

xfree m

5 YEARS
WARRANTY



EN

System of light fittings, linear and curved, with suspended mounting, for continuous luminous structures, direct and indirect light, equipped with LEDs modules.

Linear connectors, at 90°, in T or cross mounting are available as accessories.

The light fittings from this range can be mounted also as individual luminaires using the appropriate accessories.

All the mounting and connecting accessories have to be ordered separately.

Extruded aluminum profile, electrostatically painted with sandblasted finishing.

Support for LEDs modules and driver in profile of extruded aluminum.

Satin opal diffusers in polycarbonate.

Constant current LED driver for both direct and indirect modules.

Two blocks of terminals, self locking type 2P+N, one at each side, to assemble the continuous structures.

Range of applications

General or local lighting in offices, reception areas, conference rooms or public working spaces.

RO

Sistem de corpuri de iluminat pentru montaj suspendat, cu posibilitatea de realizare a structurilor luminoase continue, echipate cu module cu LED-uri.

Sunt disponibile accesorii pentru conexiunea liniară, cu unghiuri la 90°, în T sau în cruce.

Corpurile de iluminat pot fi montate și individual utilizând accesoriile corespunzătoare.

Toate accesorii de montaj și de conexiune se comandă separat.

Profil din aluminiu extrudat, vopsit în câmp electrostatic, cu finisaj sablat.

Support pentru modulele cu LED-uri și alimentator din profil de aluminiu extrudat.

Dispersoare opale satinat din policarbonat.

Alimentator în curent constant pentru ambele module LED (direct și indirect).

Două cleme de conexiuni 2P+N cu autoblocare, câte una la fiecare capăt, conectate între ele pentru realizarea de structuri continue.

Aplicații

Iluminat general sau local în birouri, zone de recepție, săli de conferințe sau spații de lucru cu publicul.

IT

Sistema di apparecchi per montaggio a sospensione, dotati di moduli a LED, permettendo la realizzazione di strutture luminose continue.

Sono disponibili come accessori, connettori lineari e angolari a L, T e X.

Apparecchi di questo sistema, possono anche essere montati singolarmente utilizzando gli accessori appropriati.

Tutti gli accessori di montaggio e di connessione devono essere ordinati separatamente.

Profilo estruso di alluminio, verniciato a polveri, finitura sabbiata.

Supporto per moduli a LED e alimentatore in profilo estruso di alluminio.

Diffusori in policarbonato satinato opalino.

Alimentatore a corrente costante per entrambi i moduli LED (diretto e indiretto).

Due morsetti 2P+N autobloccante, uno a ciascuna estremità, collegati tra loro in modo da ottenere una struttura continua.

Campi di applicazione

Illuminazione generale o locale di uffici, zone di ricezione, sale conferenza o spazi pubblici.



xfree m

LINEAR PROFILES

FINISHING AVAILABLE

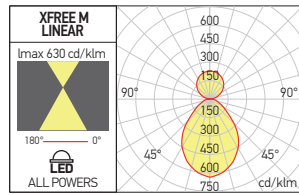

Code standard Code DALI	Finishing	LED type	Power	Input voltage	Output current/voltage driver standard/DALI	Driver	LED flux	System flux	CCT	CRI	Optics	Length (L)	Weight
FEM50WW18+6 SWH	SWH	Linear LEDs module	24W 6 up / 18 down	220-240V AC	Standard: 600 mA / 33-40V DC DALI 600 mA / 25-42V DC	Included	2800 lm	1945 lm	3000K	90	100°	562 mm	1,30 kg
FEM50WW18+6DALI SWH							700 up	488 up					
FEM50WW18+6 SBK	SBK	Linear LEDs module	24W 6 up / 18 down	220-240V AC	Standard: 600 mA / 33-40V DC DALI 600 mA / 25-42V DC	Included	2960 lm	2058 lm	4000K	90	100°	562 mm	1,30 kg
FEM50NW18+6 SWH	SWH						740 up	518 up					
FEM50NW18+6DALI SWH	SWH	Linear LEDs module	48W 12 up / 36 down	220-240V AC	Standard: 1150 mA / 33-40V DC DALI 1150 mA / 25-42V DC	Included	5600 lm	3896 lm	3000K	90	100°	1122 mm	2,60 kg
FEM50WW36+12 SBK	SBK						1400 up	977 up					
FEM50WW36+12 DALI SBK	SBK	Linear LEDs module	48W 12 up / 36 down	220-240V AC	Standard: 1150 mA / 33-40V DC DALI 1150 mA / 25-42V DC	Included	5920 lm	4144 lm	4000K	90	100°	1122 mm	2,60 kg
FEM50NW36+12 SWH	SWH						1480 up	1036 up					
FEM50NW36+12 DALI SWH	SWH	Linear LEDs module	60W 15 up / 45 down	220-240V AC	Standard: 1450 mA / 33-40V DC DALI 1450 mA / 25-42V DC	Included	7000 lm	4869 lm	3000K	90	100°	1402 mm	3,30 kg
FEM50WW45+15 SBK	SBK						1750 up	1215 up					
FEM50WW45+15 DALI SBK	SBK	Linear LEDs module	60W 15 up / 45 down	220-240V AC	Standard: 1450 mA / 33-40V DC DALI 1450 mA / 25-42V DC	Included	7400 lm	5177 lm	4000K	90	100°	1402 mm	3,30 kg
FEM50NW45+15 SWH	SWH						1850 up	1293 up					
FEM50NW45+15 DALI SWH	SWH	Linear LEDs module	80W 20 up / 60 down	220-240V AC	Standard: 2000 mA / 33-40V DC DALI 2000 mA / 25-42V DC	Included	9800 lm	6484 lm	3000K	90	100°	1962 mm	4,50 kg
FEM50WW60+20 SBK	SBK						2450 up	1626 up					
FEM50WW60+20 DALI SBK	SBK	Linear LEDs module	80W 20 up / 60 down	220-240V AC	Standard: 2000 mA / 33-40V DC DALI 2000 mA / 25-42V DC	Included	10360 lm	6885 lm	4000K	90	100°	1962 mm	4,50 kg
FEM50NW60+20 SWH	SWH						2590 up	1723 up					
FEM50NW60+20 DALI SWH	SWH	Linear LEDs module	80W 20 up / 60 down	220-240V AC	Standard: 2000 mA / 33-40V DC DALI 2000 mA / 25-42V DC	Included	10360 lm	6885 lm	4000K	90	100°	1962 mm	4,50 kg
FEM50NW60+20 SBK	SBK						2590 up	1723 up					

Linear light fittings for suspended mounting, for continuous luminous lines, with connection at 90°, in T or cross mounting, or for individual installing, equipped with LEDs modules, powered at 48V DC.

Corpurile de iluminat liniare cu montaj suspendat, cu posibilitatea de realizare a structurilor liniare continue, cu unghiuri la 90°, în T sau în cruce, sau cu instalare individuală, echipate cu module cu LED-uri la 48V DC.

Apparecchi lineari per montaggio a sospensione, dotati di moduli lineari a LED SMD a 48V DC, permettendo la realizzazione di strutture luminose lineari, con angoli a 90°, connessioni a T o a croce, o montaggio singolarmente.

IMPORTANT 

The luminaires of the XFREE M family can be equipped with dimmable DALI drivers. In this case, the power supply cable must be 2P+N+2P (3x1 mm² + 2x0.5 mm², control circuit).

The DALI light fittings from XFREE M family can be dimmed by the following methods, using TRIDONIC/CASAMBI protocol:

- by means of TRIDONIC basicDIM Wireless Passive Module G2 wireless controller, for DALI drivers (with or without integrated DALI source).
- with the help of basicDIM Wireless G2, the DALI controller with integrated DALI source, for DALI drivers.

Can be also equipped with emergency kits (excluding luminaires with length of 0,56m). The kits are ordered separately and, to ensure the guarantee, have to be installed by ARELUX specialists.

Corpurile de iluminat din familia XFREE M pot fi echipate cu alimentatoare dimabile DALI. In acest caz cablul de alimentare trebuie să fie 2P+N+2P (3x1 mm² + 2x0,5 mm², circuitul de comandă).

Corpurile de iluminat DALI din familia XFREE M pot fi reglate prin următoarele metode, folosind protocolul TRIDONIC/CASAMBI:

- utilizând regulatorul wireless basicDIM Wireless Passive Module G2, TRIDONIC, în sistem DALI, pentru alimentatoare DALI (cu sau fără sursă DALI integrată).
- cu ajutorul basicDIM Wireless G2, regulatorul DALI cu sursă DALI integrată, pentru alimentatoare DALI.

Pot fi de asemenea echipate cu kit-uri de urgență (cu excepția corpurilor cu lungimea de 0,56m). Kit-urile se comandă separat și pentru asigurarea garanției se instalează de către specialiștii ARELUX.

Gli apparecchi di famiglia XFREE M possono essere dotati di alimentatori dimmerabili DALI. In questo caso il cavo di alimentazione deve essere 2P+N+2P (3x1 mm² + 2x0,5 mm², circuito di controllo).

Gli apparecchi illuminanti DALI della famiglia XFREE M possono essere regolati nei seguenti modi, usando il protocollo TRIDONIC/CASAMBI:

- utilizzando il controller wireless TRIDONIC basicDIM Wireless Passive Module G2, sistema DALI, per alimentatori DALI (con o senza sorgente DALI integrata).
- con l'ausilio di basicDIM Wireless G2, il controller DALI con sorgente DALI integrata, per alimentatori DALI.

Possono essere equipaggiati con kit di emergenza (senza apparecchi con lunghezza di 0,56m). I kit vengono ordinati separatamente e, per mantenere la garanzia, devono essere installati da specialisti ARELUX.

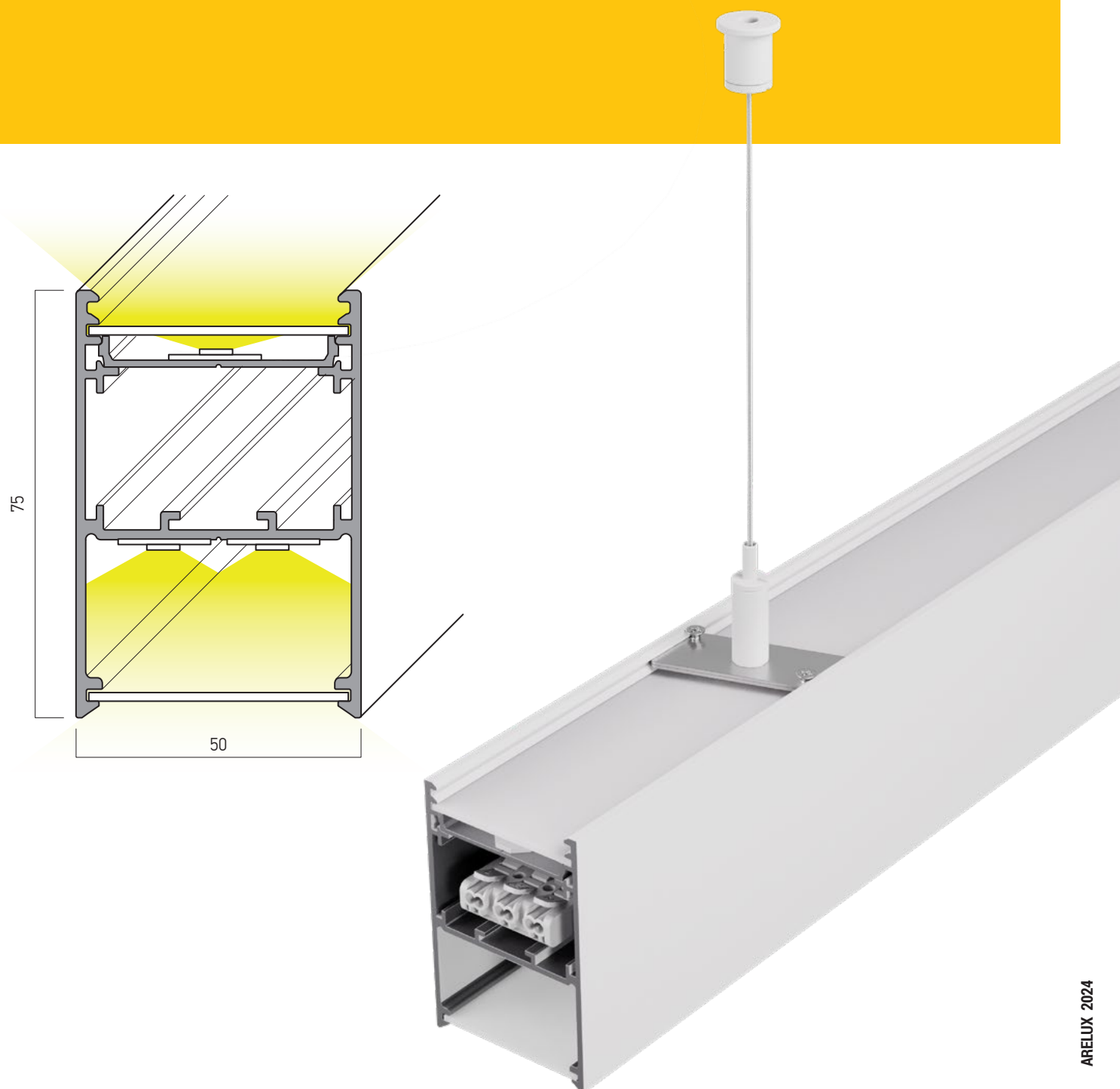

xfree m

CURVED PROFILES

FINISHING AVAILABLE

SWH SBK

DALI

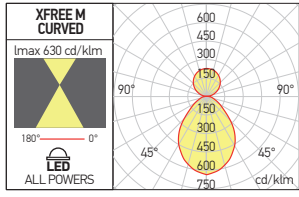

- CE
- LED
- House icon
- Grounding symbol
- IP40
- Dimmer icon
- Arrow icon

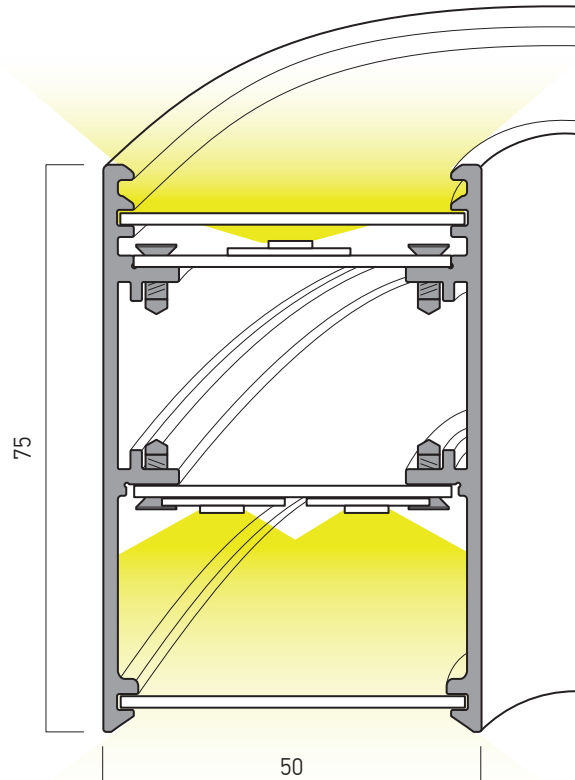
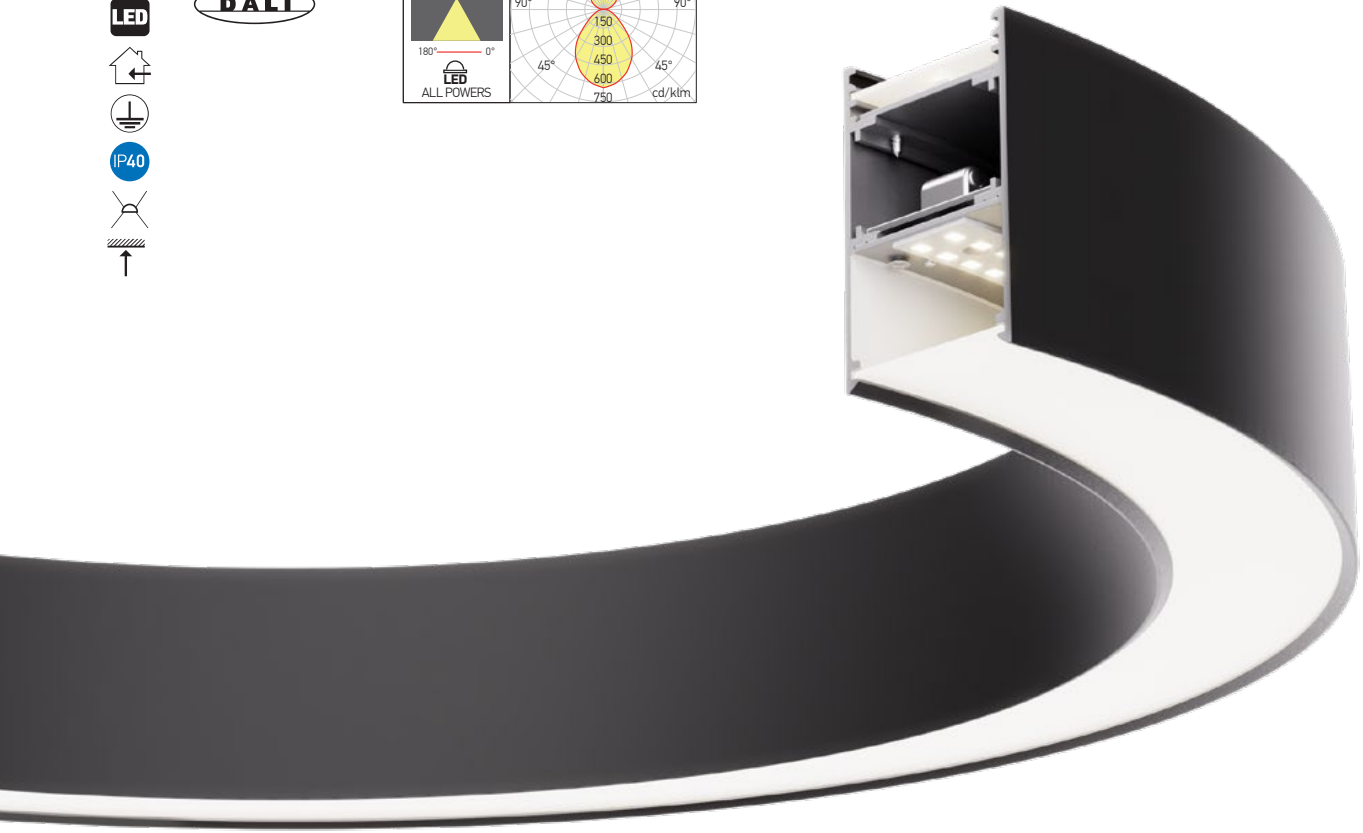

CURVED PROFILES

Light fittings with curved shape, for suspended mounting, installing in continous lines or individual mounting. Equipped with 48V DC, SMD LEDs modules.

Corpuri de iluminat cu formă rotundă pentru montaj suspendat, instalare în structuri continue sau individual. Sunt echipate cu module cu LED-uri SMD alimentate la 48V DC.

Apparecchi archi di cerchi per installazione come sospensione in strutture continue o singole. Dotati di moduli LED SMD alimentati a 48V DC.

CURVED RADIUS AND SECTORS DEGREE AVAILABLE

	22,5°	30°	45°	60°	90°	120°	180°
Curvature radius							
300mm	-	-	-	-	-	-	✓
500mm	-	-	-	✓	✓	✓	✓
750mm	✓	-	✓	-	✓	-	-
1000mm	-	-	-	-	✓	-	✓
1200mm	-	-	✓	-	-	-	-
1500mm	✓	-	✓	✓	✓	-	-
2000mm	-	-	✓	-	-	-	-
2400mm	-	-	✓	-	-	-	-
3000mm	-	✓	✓	-	-	-	-



750mm CURVATURE RADIUS



Code standard Ccode DALI	Finishing	LED type	Power	Input voltage	Output current/voltage driver standard/DALI	Driver	LED flux	System flux	CCT	CRI	Optics	Weight
FEM75WW22.5 SWH	SWH	Linear LEDs module	12W 3 up 9 down	220-240V AC	Standard: 300 mA / 33-40V DC DALI 300 mA / 25-42V DC	Included	1392 lm	972 lm	3000K	90	100°	0,50 kg
FEM75WW22.5DALI SWH							348 up	244 up				
FEM75WW22.5 SBK	SBK						1044 down	728 down				
FEM75NW22.5 SWH	SWH						1472 lm	1035 lm				
FEM75NW22.5DALI SWH							368 up	259 up				
FEM75NW22.5 SBK	SBK						1104 down	776 down				

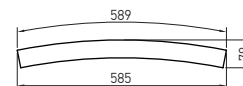

1500mm CURVATURE RADIUS

Code standard Ccode DALI	Finishing	LED type	Power	Input voltage	Output current/voltage driver standard/DALI	Driver	LED flux	System flux	CCT	CRI	Optics	Weight
FEM150WW22.5 SWH	SWH	Linear LEDs module	24W 6 up 18 down	220-240V AC	Standard: 600 mA / 33-40V DC DALI 600 mA / 25-42V DC	Included	2952 lm	1949 lm	3000K	90	100°	1 kg
FEM150WW22.5DALI SWH							738 up	488 up				
FEM150WW22.5 SBK	SBK						2214 down	1461 down				
FEM150NW22.5 SWH	SWH						3104 lm	2057 lm				
FEM150NW22.5DALI SWH							776 up	515 up				
FEM150NW22.5 SBK	SBK						2328 down	1542 down				

xfree m





xfree m

CURVED PROFILES

FINISHING AVAILABLE

SWH

SBK



3000mm CURVATURE RADIUS

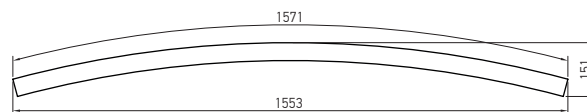

Code standard Code DALI	Finishing	LED type	Power	Input voltage	Output current/voltage driver standard/DALI	Driver	LED flux	System flux	CCT	CRI	Optics	Weight
FEM300WW30 SWH	SWH	Linear LEDs module	64W 16W up 48W down	220-240V AC	Standard: 1600 mA / 33-40V DC DALI 1600mA / 25-42V DC	Included	7840 lm	5180 lm	3000K	90	100°	2,60 kg
FEM300WW30DALI SWH							1960 up	1293 up				
FEM300WW30 SBK	SBK						5880 down	3887 down				
FEM300WW30DALI SBK	SBK											
FEM300NW30 SWH	SWH											
FEM300NW30DALI SWH	SWH											
FEM300NW30 SBK	SBK							4000K				
FEM300NW30DALI SBK	SBK						8288 lm	5510 lm				
							2072 up	1376 up				
							6216 down	4134 down				



750mm CURVATURE RADIUS

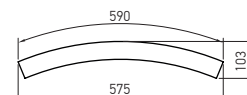

Code standard Code DALI	Finishing	LED type	Power	Input voltage	Output current/voltage driver standard/DALI	Driver	LED flux	System flux	CCT	CRI	Optics	Weight
FEM75WW45 SWH	SWH	Linear LEDs module	24W 6 up 18 down	220-240V AC	Standard: 600 mA / 33-40V DC DALI 600 mA / 25-42V DC	Included	2952 lm	1949 lm	3000K	90	100°	1,00 kg
FEM75WW45DALI SWH							738 up	488 up				
FEM75WW45 SBK	SBK						2214 down	1461 down				
FEM75WW45DALI SBK	SBK											
FEM75NW45 SWH	SWH											
FEM75NW45DALI SWH	SWH											
FEM75NW45 SBK	SBK						3104 lm	2057 lm	4000K			
							776 up	515 up				
							2328 down	1542 down				

1200mm CURVATURE RADIUS



Code standard Code DALI	Finishing	LED type	Power	Input voltage	Output current/voltage driver standard/DALI	Driver	LED flux	System flux	CCT	CRI	Optics	Weight
FEM120WW45 SWH	SWH	Linear LEDs module	40W 10 up 30 down	220-240V AC	Standard: 1000 mA / 33-40V DC DALI 1000 mA / 25-42V DC	Included	4752 lm	3244 lm	3000K	90	100°	1,60 kg
FEM120WW45DALI SWH							1188 up	812 up				
FEM120WW45 SBK	SBK						3564 down	2432 down				
FEM120WW45DALI SBK	SBK											
FEM120NW45 SWH	SWH											
FEM120NW45DALI SWH	SWH											
FEM120NW45 SBK	SBK						5040 lm	3452 lm	4000K			
							1260 up	863 up				
							3780 down	2589 down				

1500mm CURVATURE RADIUS

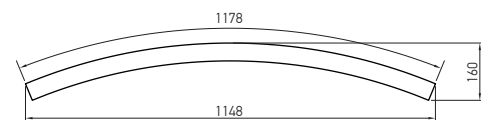

Code standard Code DALI	Finishing	LED type	Power	Input voltage	Output current/voltage driver standard/DALI	Driver	LED flux	System flux	CCT	CRI	Optics	Weight
FEM150WW45 SWH	SWH	Linear LEDs module	45W 11 up 34 down	220-240V AC	Standard: 1150 mA / 33-40V DC DALI 1150 mA / 25-42V DC	Included	5512 lm	3653 lm	3000K	90	100°	2,00 kg
FEM150WW45DALI SWH							1378 up	894 up				
FEM150WW45 SBK	SBK						4134 down	2759 down				
FEM150WW45DALI SBK	SBK											
FEM150NW45 SWH	SWH											
FEM150NW45DALI SWH	SWH											
FEM150NW45 SBK	SBK						5828 lm	3873 lm	4000K			
							1457 up	948 up				
							4371 down	2925 down				



2000mm CURVATURE RADIUS

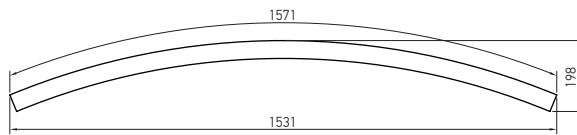

Code standard Ccode DALI	Finishing	LED type	Power	Input voltage	Output current/voltage driver standard/DALI	Driver	LED flux	System flux	CCT	CRI	Optics	Weight
FEM200WW45 SWH	SWH	Linear LEDs module	64W 16W up 48W down	220-240V AC	Standard: 1600 mA / 33-40V DC DALI 1600 mA / 25-42V DC	Included	7840 lm	5180 lm	3000K	90	100°	2,70 kg
FEM200WW45DALI SWH	SWH						1960 up	1293 up				
FEM200WW45 SBK	SBK						5880 down	3887 down				
FEM200NW45 SWH	SWH						8288 lm	5510 lm				
FEM200NW45DALI SWH	SWH						2072 up	1376 up				
FEM200NW45 SBK	SBK						6216 down	4134 down				
FEM200NW45DALI SBK	SBK											

2400mm CURVATURE RADIUS

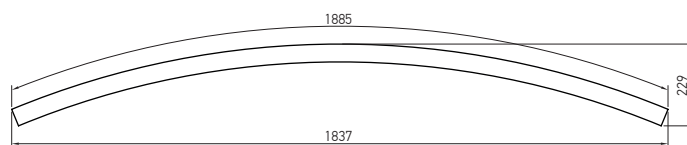

Code standard Ccode DALI	Finishing	LED type	Power	Input voltage	Output current/voltage driver standard/DALI	Driver	LED flux	System flux	CCT	CRI	Optics	Weight
FEM240WW45 SWH	SWH	Linear LEDs module	76W 19 up 57 down	220-240V AC	Standard: 2000 mA / 33-40V DC DALI 2000 mA / 25-42V DC	Included	9072 lm	6165 lm	3000K	90	100°	3,00 kg
FEM240WW45DALI SWH	SWH						2268 up	1542 up				
FEM240WW45 SBK	SBK						6804 down	4623 down				
FEM240NW45 SWH	SWH						9558 lm	6507 lm				
FEM240NW45DALI SWH	SWH						2402 up	1629 up				
FEM240NW45 SBK	SBK						7156 down	4878 down				
FEM240NW45DALI SBK	SBK											

3000mm CURVATURE RADIUS

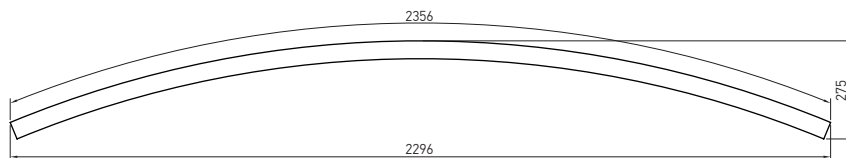

Code standard Ccode DALI	Finishing	LED type	Power	Input voltage	Output current/voltage driver standard/DALI	Driver	LED flux	System flux	CCT	CRI	Optics	Weight
FEM300WW45 SWH	SWH	Linear LEDs module	96W 24 up 72 down	220-240V AC	Standard: 600 +1700 mA / 33-40V DC DALI 600 +1700 mA / 25-42V DC	Included	11424 lm	7787 lm	3000K	90	100°	4,00 kg
FEM300WW45DALI SWH	SWH						2856 up	1949 up				
FEM300WW45 SBK	SBK						8568 down	5838 down				
FEM300NW45 SWH	SWH						12080 lm	8215 lm				
FEM300NW45DALI SWH	SWH						3020 up	2056 up				
FEM300NW45 SBK	SBK						9060 down	6159 down				
FEM300NW45DALI SBK	SBK											



500mm CURVATURE RADIUS



Code standard Ccode DALI	Finishing	LED type	Power	Input voltage	Output current/voltage driver standard/DALI	Driver	LED flux	System flux	CCT	CRI	Optics	Weight
FEM50WW60 SWH	SWH	Linear LEDs module	22W 5,5 up 16,5 down	220-240V AC	Standard: 600 mA / 33-40V DC DALI 600 mA / 25-42V DC	Included	2656 lm	1786 lm	3000K	90	100°	0,90 kg
FEM50WW60DALI SWH	SWH						664 up	447 up				
FEM50WW60 SBK	SBK						1992 down	1339 down				
FEM50NW60 SWH	SWH						2786 lm	1885 lm				
FEM50NW60DALI SWH	SWH						696 up	472 up				
FEM50NW60 SBK	SBK						2088 down	1413 down				
FEM50NW60DALI SBK	SBK											

xfree m

CURVED PROFILES FINISHING AVAILABLE

SWH SBK



1500mm CURVATURE RADIUS

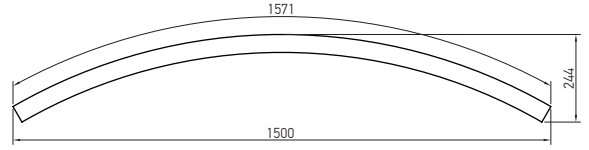

Code standard Code DALI	Finishing	LED type	Power	Input voltage	Output current/voltage driver standard/DALI	Driver	LED flux	System flux	CCT	CRI	Optics	Weight
FEM150WW60 SWH	SWH	Linear LEDs module	64W 16 up 48 down	220-240V AC	Standard: 1600 mA / 33-40V DC DALI 1600 mA / 25-42V DC	Included	7840 lm	5180 lm	3000K	90	100°	2,60 kg
FEM150WW60DALI SWH							1960 up	1293 up				
FEM150WW60 SBK	SBK						5880 down	3887 down				
FEM150NW60 SWH	SWH						8288 lm	5510 lm				
FEM150NW60DALI SWH							2072 up	1376 up				
FEM150NW60 SBK	SBK						6216 down	4134 down				



500mm CURVATURE RADIUS

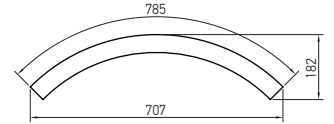

Code standard Code DALI	Finishing	LED type	Power	Input voltage	Output current/voltage driver standard/DALI	Driver	LED flux	System flux	CCT	CRI	Optics	Weight
FEM50WW90 SWH	SWH	Linear LEDs module	32W 8 up 24 down	220-240V AC	Standard: 900 mA / 33-40V DC DALI 900 mA / 25-42V DC	Included	3744 lm	2604 lm	3000K	90	100°	1,40 kg
FEM50WW90DALI SWH							936 up	651 up				
FEM50WW90 SBK	SBK						2808 down	1953 down				
FEM50NW90 SWH	SWH						4032 lm	2745 lm				
FEM50NW90DALI SWH							1008 up	687 up				
FEM50NW90 SBK	SBK						3024 down	2058 down				

750mm CURVATURE RADIUS

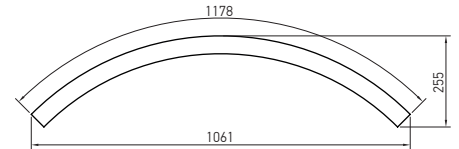

Code standard Code DALI	Finishing	LED type	Power	Input voltage	Output current/voltage driver standard/DALI	Driver	LED flux	System flux	CCT	CRI	Optics	Weight
FEM75WW90 SWH	SWH	Linear LEDs module	48W 12 up 36 down	220-240V AC	Standard: 1150 mA / 33-40V DC DALI 1150 mA / 25-42V DC	Included	5600 lm	3896 lm	3000K	90	100°	2,40 kg
FEM75WW90DALI SWH							1400 up	977 up				
FEM75WW90 SBK	SBK						4200 down	2919 down				
FEM75NW90 SWH	SWH						5952 lm	4109 lm				
FEM75NW90DALI SWH							1488 up	1031 up				
FEM75NW90 SBK	SBK						4464 down	3078 down				

1000mm CURVATURE RADIUS

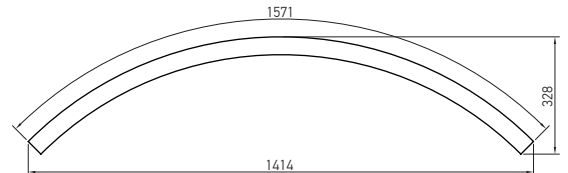

Code standard Code DALI	Finishing	LED type	Power	Input voltage	Output current/voltage driver standard/DALI	Driver	LED flux	System flux	CCT	CRI	Optics	Weight
FEM100WW90 SWH	SWH	Linear LEDs module	64W 16 up 48 down	220-240V AC	Standard: 1600 mA / 33-40V DC DALI 1600 mA / 25-42V DC	Included	7840 lm	5180 lm	3000K	90	100°	2,60 kg
FEM100WW90DALI SWH							1960 up	1293 up				
FEM100WW90 SBK	SBK						5880 down	3887 down				
FEM100NW90 SWH	SWH						8288 lm	5510 lm				
FEM100NW90DALI SWH							2072 up	1376 up				
FEM100NW90 SBK	SBK						6216 down	4134 down				



1500mm CURVATURE RADIUS

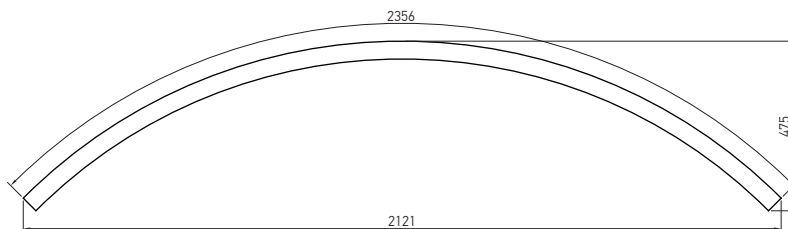

Code standard Ccode DALI	Finishing	LED type	Power	Input voltage	Output current/voltage driver standard/DALI	Driver	LED flux	System flux	CCT	CRI	Optics	Weight
FEM150WW90 SWH	SWH	Linear LEDs module	90W 22 up 68 down	220-240V AC	Standard: 600 + 1700 mA / 33-40V DC DALI 600 + 1700 mA / 25-42V DC	Included	11072 lm	7295 lm	3000K	90	100°	4,00 kg
FEM150WW90DALI SWH	SWH						2768 up	1789 up				
FEM150WW90 SBK	SBK						8304 down	5506 down				
FEM150NW90 SWH	SWH						12288 lm	8257 lm				
FEM150NW90DALI SWH	SWH						3072 up	2068 up				
FEM150NW90 SBK	SBK						9216 down	6189 down				



500mm CURVATURE RADIUS

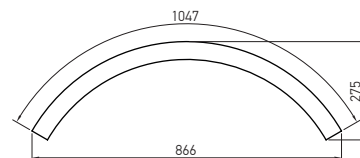

Code standard Ccode DALI	Finishing	LED type	Power	Input voltage	Output current/voltage driver standard/DALI	Driver	LED flux	System flux	CCT	CRI	Optics	Weight
FEM50WW120 SWH	SWH	Linear LEDs module	44W 11 up 33 down	220-240V AC	Standard: 1150 mA / 33-40V DC DALI 1150 mA / 25-42V DC	Included	5360 lm	3570 lm	3000K	90	100°	1,74 kg
FEM50WW120DALI SWH	SWH						1340 up	894 up				
FEM50WW120 SBK	SBK						4020 down	2676 down				
FEM50NW120 SWH	SWH						5760 lm	3780 lm				
FEM50NW120DALI SWH	SWH						1440 up	943 up				
FEM50NW120 SBK	SBK						4320 down	2837 down				



300mm CURVATURE RADIUS

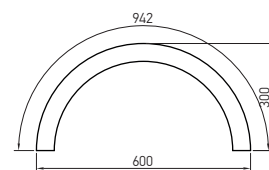

Code standard Ccode DALI	Finishing	LED type	Power	Input voltage	Output current/voltage driver standard/DALI	Driver	LED flux	System flux	CCT	CRI	Optics	Weight
FEM30WW180 SWH	SWH	Linear LEDs module	34W 8 up 26 down	220-240V AC	Standard: 900 mA / 33-40V DC DALI 900 mA / 25-42V DC	Included	4180 lm	2758 lm	3000K	90	100°	1,57 kg
FEM30WW180DALI SWH	SWH						1045 up	647 up				
FEM30WW180 SBK	SBK						3135 down	2111 down				
FEM30NW180 SWH	SWH						4404 lm	2926 lm				
FEM30NW180DALI SWH	SWH						1101 up	691 up				
FEM30NW180 SBK	SBK						3303 down	2235 down				

xfree m

CURVED PROFILES FINISHING AVAILABLE

SWH SBK

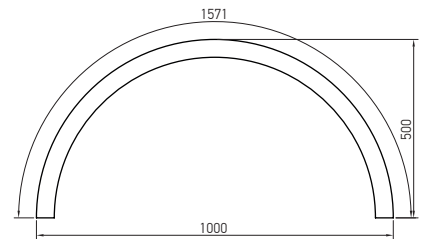

500mm CURVATURE RADIUS

Code standard Code DALI	Finishing	LED type	Power	Input voltage	Output current/voltage driver standard/DALI	Driver	LED flux	System flux	CCT	CRI	Optics	Weight
FEM50WW180 SWH	SWH	Linear LEDs module	64W 16 up 48 down	220-240V AC	Standard: 1750 mA / 33-40V DC DALI 1750 mA / 25-42V DC	Included	7840 lm	5180 lm	3000K	90	100°	2,60kg
FEM50WW180DALI SWH	SWH						1960 up	1293 up				
FEM50WW180 SBK	SBK						5880 down	3887 down				
FEM50NW180 SWH	SWH						8288 lm	5510 lm				
FEM50NW180DALI SWH	SWH						2072 up	1376 up				
FEM50NW180 SBK	SBK						6216 down	4134 down				

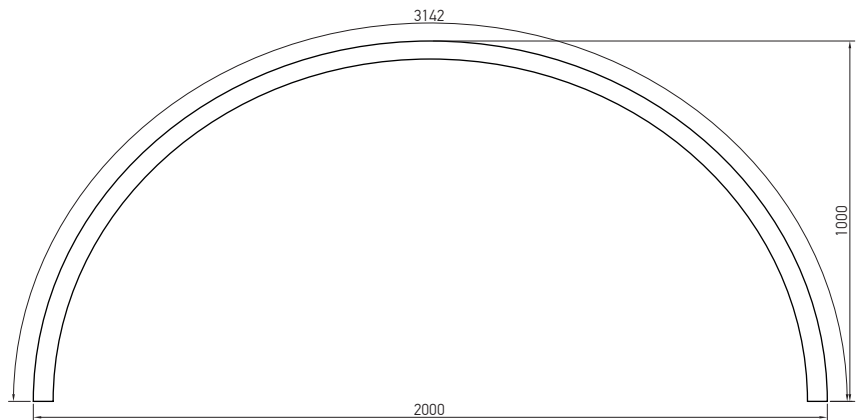

1000mm CURVATURE RADIUS

Code standard Code DALI	Finishing	LED type	Power	Input voltage	Output current/voltage driver standard/DALI	Driver	LED flux	System flux	CCT	CRI	Optics	Weight
FEM100WW180 SWH	SWH	Linear LEDs module	128W 32 up 96 down	220-240V AC	Standard: 900+2000 mA / 28-42V DC DALI 900+2000 mA / 25-42V DC	Included	15680 lm	10388 lm	3000K	90	100°	5,30 kg
FEM100WW180DALI SWH	SWH						3920 up	2596 up				
FEM100WW180 SBK	SBK						11760 down	7792 down				
FEM100NW180 SWH	SWH						16576 lm	10995 lm				
FEM100NW180DALI SWH	SWH						4144 up	2748 up				
FEM100NW180 SBK	SBK						12432 down	8247 down				



xfree m



90° L CONNECTOR

FINISHING AVAILABLE

SWH SBK



Code	Finishing	LED type	Power	Input voltage	Driver	LED flux	System flux	CCT	CRI	Optics	Weight
FEM50WWLC SWH	SWH	LEDs MODULE	11W 3 up 8 down	220-240V AC	Included	1348 lm 337 up 1011 down	895 lm 244 and 651 down	3000K	90	100°	0,80 kg
FEM50WWLC SBK	SBK	LEDs MODULE	11W 3 up 8 down	220-240V AC	Included	1348 lm 337 up 1011 down	895 lm 244 and 651 down	3000K	90	100°	0,80 kg
FEM50NWLC SWH	SWH	LEDs MODULE	11W 3 up 8 down	220-240V AC	Included	1424 lm 356 up 1068 down	948 lm 259 up 689 down	4000K	90	100°	0,80 kg
FEM50NWLC SBK	SBK	LEDs MODULE	11W 3 up 8 down	220-240V AC	Included	1424 lm 356 up 1068 down	948 lm 259 up 689 down	4000K	90	100°	0,80 kg

Structural element, suspended mounting, for connection at 90° (in L) of two light fittings from the family XFREE M. Equipped with linear SMD LEDs modules.
 Element de structură cu montaj suspendat, pentru realizarea conexiunii la 90° (in L) între două corpuri de iluminat din gama XFREE M. Echipat cu module liniare cu LED-uri SMD.
 Elemento strutturale per la connessione a 90° (in L) tra due apparecchi della gamma XFREE M, montaggio a sospensione, equipaggiato con moduli lineari a LED SMD.

T CONNECTOR

FINISHING AVAILABLE

SWH SBK

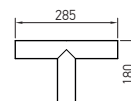
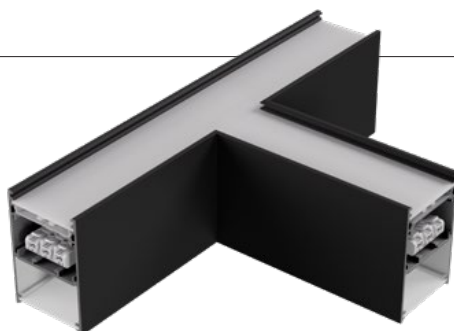

Code	Finishing	LED type	Power	Input voltage	Driver	LED flux	System flux	CCT	CRI	Optics	Weight
FEM50WWTC SWH	SWH	LEDs MODULE	17W 4 up 13 down	220-240V AC	Included	2084 lm 521 up 1563 down	1381 lm 325 up 1056 down	3000K	90	100°	1,10 kg
FEM50WWTC SBK	SBK	LEDs MODULE	17W 4 up 13 down	220-240V AC	Included	2084 lm 521 up 1563 down	1381 lm 325 up 1056 down	3000K	90	100°	1,10 kg
FEM50NWTC SWH	SWH	LEDs MODULE	17W 4 up 13 down	220-240V AC	Included	2200 lm 550 up 1650 down	1465 lm 344 up 1121 down	4000K	90	100°	1,10 kg
FEM50NWTC SBK	SBK	LEDs MODULE	17W 4 up 13 down	220-240V AC	Included	2200 lm 550 up 1650 down	1465 lm 344 up 1121 down	4000K	90	100°	1,10 kg

Structural element, suspended mounting, for connection at 90° (in T) of three light fittings from the family XFREE M. Equipped with linear SMD LEDs modules.
 Element de structură cu montaj suspendat, pentru realizarea conexiunii la 90° (in T) între trei corpuri de iluminat din gama XFREE S. Echipat cu module liniare cu LED-uri SMD.
 Elemento strutturale per la connessione a 90° (in T) tra tre apparecchi della gamma XFREE M, montaggio di superficie o a sospensione, equipaggiato con moduli lineari a LED SMD.

CROSS CONNECTOR

FINISHING AVAILABLE

SWH SBK

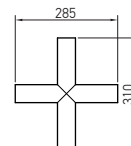
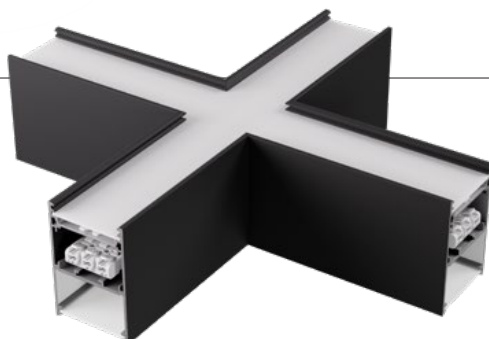

Code	Finishing	LED type	Power	Input voltage	Driver	LED flux	System flux	CCT	CRI	Optics	Weight
FEM50WWXC SWH	SWH	LEDs MODULE	22W 5 up 17 down	220-240V AC	Included	2696 lm 674 up 2022 down	1787 lm 406 up 1381 down	3000K	90	100°	1,40 kg
FEM50WWXC SBK	SBK	LEDs MODULE	22W 5 up 17 down	220-240V AC	Included	2696 lm 674 up 2022 down	1787 lm 406 up 1381 down	3000K	90	100°	1,40 kg
FEM50NWXC SWH	SWH	LEDs MODULE	22W 5 up 17 down	220-240V AC	Included	2852 lm 713 up 2139 down	1897 lm 431 up 1466 down	4000K	90	100°	1,40 kg
FEM50NWXC SBK	SBK	LEDs MODULE	22W 5 up 17 down	220-240V AC	Included	2852 lm 713 up 2139 down	1897 lm 431 up 1466 down	4000K	90	100°	1,40 kg

Structural element, suspended mounting, for connection at 90° (in X) of four light fittings from the family XFREE M. Equipped with linear SMD LEDs modules.
 Element de structură cu montaj suspendat, pentru realizarea conexiunii la 90° (in X) între patru corpuri de iluminat din gama XFREE S. Echipat cu module liniare cu LED-uri SMD.
 Elemento strutturale per la connessione a 90° (in X) tra quattro apparecchi della gamma XFREE M, montaggio di superficie o a sospensione, equipaggiato con moduli lineari a LED SMD.

END CAPS

FINISHING AVAILABLE

SWH SBK



Code	Material	Finishing	Weight
FEM35TPAL SWH	Aluminum	SWH	0,03 kg
FEM35TPAL SBK	Aluminum	SBK	0,03 kg
FEM35TPPC SWH	Polycarbonate	SWH	0,02 kg
FEM35TPPC SBK	Polycarbonate	SBK	0,02 kg

Set of two end caps of aluminum or polycarbonate for the light fittings and luminous structures of the family XFREE M.

Set de două elemente terminale din aluminiu sau policarbonat pentru corpurile de iluminat și structurile luminoase din familia XFREE M.

Set composto da due testate di chiusura in alluminio o policarbonato per apparecchi e strutture luminose della famiglia XFREE M.

CEILING CUP

FINISHING AVAILABLE

SWH SBK



Code	Finishing	Weight
FEM50PK SWH	SWH	0,13 kg
FEM50PK SBK	SBK	0,13 kg

Ceiling cup for electrical connections, with 2P+N, 3x1 mm², power supply cable, 2m maximum length and 2P+N self-locking block of terminal.

Accesoriu de tavan pentru legăturile electrice, cu cablu de alimentare 2P+N, 3x1 mm² având lungimea maximă de 2m și șir de cleme 2P+N cu autoblocare.

Basetta con montaggio a soffitto, per gli collegamenti elettrici, cavo di alimentazione 2P+N, 3x1 mm², lunghezza massima da 2m e morsetteria autobloccante 2P+N.

CONNECTION SYSTEM



Code	Finishing	Weight
FEM50CK	Chrome	0,06 kg

System for linear connection of two profiles or angular connectors of the XFREE M family consisting of 3 metal parts (two dimensions) with four holes and recessed screws for fixing.

Sistem pentru conectarea liniară a două profile sau conectoare unghiulare din familia XFREE M, compus din 3 piese metalice (două dimensiuni) cu câte patru găuri și șuruburi de fixare incastrate.

Sistema di connessione per due profili lineari o connettori angolari della famiglia XFREE M, composto di 3 parti metalliche (due dimensioni) con quattro fori e viti incorporate per fissaggio.

SUSPENSION KIT

FINISHING AVAILABLE

SWH SBK



Code	Finishing	Weight
FEM50SK SWH	SWH	0,05 kg
FEM50SK SBK	SBK	0,05 kg

Suspension kit (two pieces) for XFREE M light fittings or structures, with a maximum length of 1,5m.

Cable of twisted steel wires with steel fittings for fixing on the ceiling and on the light fitting.

Kit de suspendare (set de două piese) pentru corpurile sau structurile XFREE M, cu lungimea maximă de 1,5m.

Cablu torsadat din fire de oțel, cu accesorii de fixare din oțel pentru tavan și corpul de iluminat.

Kit di sospensione (due pezzi) per apparecchi singoli o per composizioni XFREE M, con lunghezza massima di 1,5m.

Filo di acciaio intrecciato, con accessori di fissaggio in acciaio per soffitto e per apparecchio.

OPAL DIFFUSER



Code	Length	Weight
FEM50FDD300	3000 mm	0,35 kg

Satin opal polycarbonate diffuser, 3000 mm length, for direct lighting of the XFREE M system components.

Dispensator satinat opal din policarbonat, lungimea de 3000 mm, pentru iluminatul direct la componentelor sistemului XFREE M.

Diffusore opalino satinato in policarbonato, lunghezza 3000 mm, per l'illuminazione diretta dei componenti del sistema XFREE M.

