





























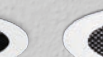



downlights

● LIRALIGHTING®
Enjoy Our Light

index

	STAX 75	STAX 75 DEEP	STAX 95	STAX 95 DEEP	STAX 100	STAX 100 DEEP	STAX 140
page/strona	10	11	12	13	14	15	16
							
opal glass							
clear glass							
honeycomb							
	LUX 135 WHITE	LUX 135 BLACK	LUX 135 WHITE - LENS	LUX 135 BLACK - LENS	LUX 190		
page/strona	24	25	26	26	27		
							
opal							
microprism							
honeycomb microprism							

**STAX 140
DEEP**

17



STAX 180

18



**STAX 180
DEEP**

19



STAX 250

20

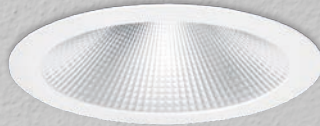

**STAX 250
DEEP**

21

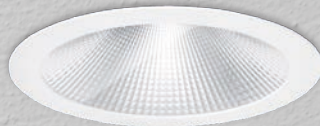
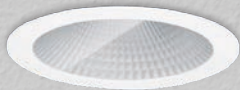
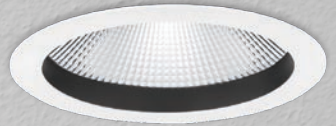

COMET 85

30



COMET 120

30



SPIN 120

33



SPIN 160

33



SPIN 230

33



STAX

Stax luminaires are an innovative range of professional built-in luminaires. It was created to combine high parameters of lighting control with excellent visual comfort. Lighting factor at the level of $UGR < 11$, for selected options, which provides comfortable and effective lighting solutions. The Stax family of luminaires is a series of luminaires of various dimensions and powers while maintaining a uniform design, which ensures versatility in many applications, including communication routes, office and commercial facilities, conference rooms, hotels.

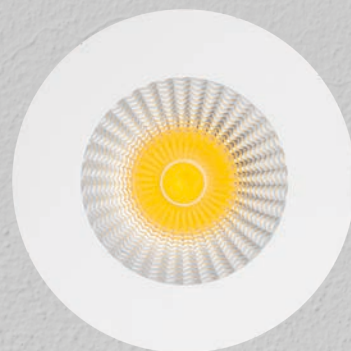

STAX 75

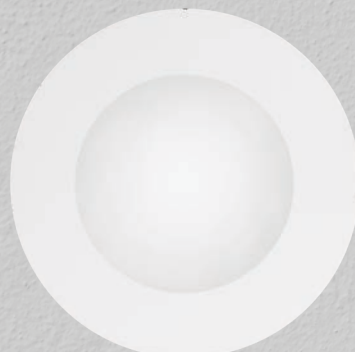

STAX 75
opal glass

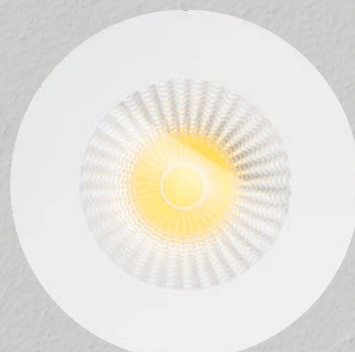

STAX 75
clear glass

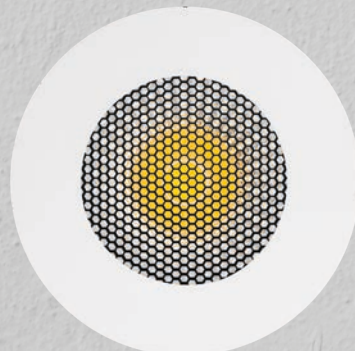

STAX 75
honeycomb



opal glass

clear glass

honeycomb

Oprawy Stax to innowacyjna gama profesjonalnych opraw do wbudowania. Stworzona została z myślą połączenia ze sobą wysokich parametrów kontroli oświetlenia z doskonałym komfortem wizualnym. Współczynnik oświetlenia na poziomie $UGR < 11$, dla wybranych opcji, zapewnia komfortowe i efektywne rozwiązania oświetleniowe. Rodzina opraw Stax to seria opraw o różnych gabarytach i mocach przy zachowaniu jednolitego wzornictwa. To zapewnia wszechstronność w wielu zastosowaniach m.in. ciągach komunikacyjnych, obiektach biurowych i handlowych, salach konferencyjnych, hotelach.

STAX DEEP

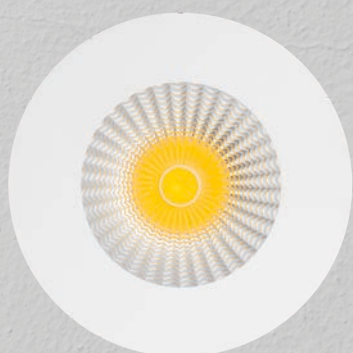

STAX 75 DEEP

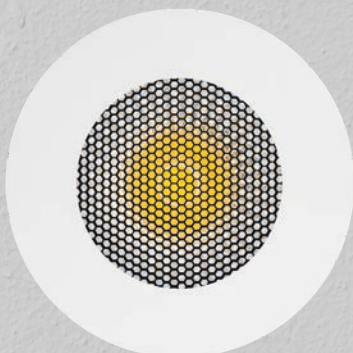







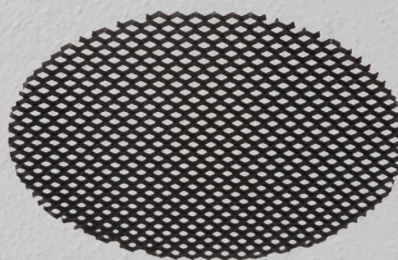















STAX 75 DEEP
honeycomb



honeycomb



STAX FAMILY

	STAX 75	STAX 75 DEEP	STAX 95	STAX 95 DEEP	STAX 100	STAX 100 DEEP	STAX 140
							
opal glass							
clear glass							
honeycomb							

**STAX 140
DEEP**

STAX 180

**STAX 180
DEEP**

STAX 250

**STAX 250
DEEP**

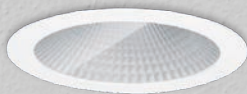
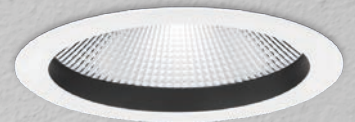
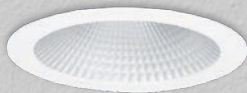



STAX 75				STAX 75 OPAL GLASS				STAX 75 CLEAR GLASS				STAX 75 HONEYCOMB			
6W	UGR<18	IP20		6W	UGR<25	IP44/20		6W	UGR<18	P44/20		6W	UGR<12	IP20	
4001.02ELC	2700K	565lm	94lm/W	4001.12ELC	2700K	517lm	86lm/W	4001.22ELC	2700K	544lm	91lm/W	4001.32ELC	2700K	433lm	72lm/W
4001.03ELC	3000K	589lm	98lm/W	4001.13ELC	3000K	538lm	90lm/W	4001.23ELC	3000K	567lm	95lm/W	4001.33ELC	3000K	451lm	75lm/W
4001.04ELC	4000K	613lm	102lm/W	4001.14ELC	4000K	560lm	93lm/W	4001.24ELC	4000K	590lm	98lm/W	4001.34ELC	4000K	469lm	78lm/W
10W	UGR<20	IP20		10W	UGR<26	IP44/20		10W	UGR<20	IP44/20		10W	UGR<13	IP20	
4002.02ELC	2700K	901lm	90lm/W	4002.12ELC	2700K	823lm	82lm/W	4002.22ELC	2700K	867lm	87lm/W	4002.32ELC	2700K	689lm	69lm/W
4002.03ELC	3000K	938lm	94lm/W	4002.13ELC	3000K	857lm	86lm/W	4002.23ELC	3000K	903lm	90lm/W	4002.33ELC	3000K	718lm	72lm/W
4002.04ELC	4000K	977lm	98lm/W	4002.14ELC	4000K	892lm	89lm/W	4002.24ELC	4000K	941lm	94lm/W	4002.34ELC	4000K	748lm	75lm/W

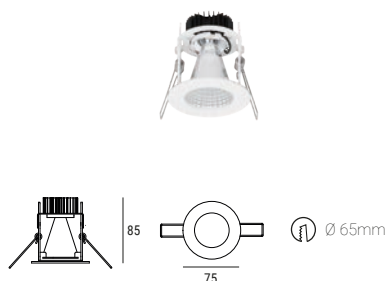

mounting type montaż	ceiling recessed dostropowy
body korpus	steel stal
reflector odbłyśnik	aluminum aluminium
type of source rodzaj źródła	LED
operating temperature range zakres temperatury pracy	from -20°C to +40°C od -20°C do +40°C
lifetime L80B10 żywność L80B10	100 000h
light distribution rozsył światła	symmetrical symetryczny
tolerance of luminous flux tolerancja strumienia świetlnego	+/-10%
colour tolerance tolerancja barwowa SDCM	SDCM<3
nominal voltage napięcie znamionowe	220-240V AC
box karton	200X150X150mm
weight waga	0,2kg

E - electronics/elektronika

L - optics/optyka

C - colours/kolory

0 - on/off
D - DALI
C - Casambi

36 - 36°

03 white
biały06 grey
szary70 anthracite
antracyt05 black
czarny



STAX 75 DEEP			
	6W	UGR<12	IP20
4003.02ELC	2700K	398lm	66lm/W
4003.03ELC	3000K	414lm	69lm/W
4003.04ELC	4000K	431lm	72lm/W
	10W	UGR<13	IP20
4004.02ELC	2700K	634lm	63lm/W
4004.03ELC	3000K	660lm	66lm/W
4004.04ELC	4000K	687lm	69lm/W

STAX 75 DEEP HONEYCOMB			
	6W	UGR<10	IP20
4003.32ELC	2700K	314lm	52lm/W
4003.33ELC	3000K	327lm	55lm/W
4003.34ELC	4000K	341lm	57lm/W
	10W	UGR<11	IP20
4004.32ELC	2700K	500lm	50lm/W
4004.33ELC	3000K	521lm	52lm/W
4004.34ELC	4000K	543lm	54lm/W

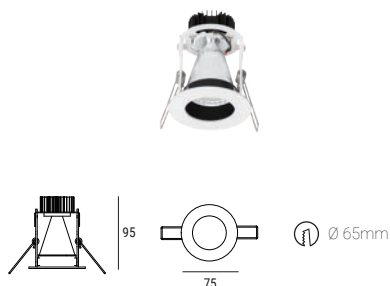

mounting type montaż	ceiling recessed dostropowy
body korpus	steel stal
reflector odbłyśnik	aluminum aluminium
type of source rodzaj źródła	LED
operating temperature range zakres temperatury pracy	from -20°C to +40°C od -20°C do +40°C
lifetime L80B10 żywołność L80B10	100 000h
light distribution rozsył światła	symmetrical symetryczny
tolerance of luminous flux tolerancja strumienia świetlnego	+/-10%
colour tolerance tolerancja barwowa SDCM	SDCM<3
nominal voltage napięcie znamionowe	220-240V AC
box karton	200X150X150mm
weight waga	0,2kg

E - electronics/elektronika

L - optics/optyka

C - colours/kolory

0 - on/off
D - DALI
C - Casambi

36 - 36°

03 white
biały06 grey
szary70 anthracite
antracyt05 black
czarny



STAX 95				STAX 95 OPAL GLASS				STAX 95 CLEAR GLASS				STAX 95 HONEYCOMB			
12W	UGR<19	IP20		12W	UGR<26	IP44/20		12W	UGR<19	IP44/20		12W	UGR<15	IP20	
4005.02ELC	2700K	1263lm	105lm/W	4005.12ELC	2700K	1149lm	96lm/W	4005.22ELC	2700K	1220lm	102lm/W	4005.32ELC	2700K	951lm	79lm/W
4005.03ELC	3000K	1315lm	110lm/W	4005.13ELC	3000K	1197lm	100lm/W	4005.23ELC	3000K	1271lm	106lm/W	4005.33ELC	3000K	990lm	83lm/W
4005.04ELC	4000K	1371lm	114lm/W	4005.14ELC	4000K	1247lm	104lm/W	4005.24ELC	4000K	1324lm	110lm/W	4005.34ELC	4000K	1032lm	86lm/W
19W	UGR<20	IP20		19W	UGR<28	IP44/20		19W	UGR<20	IP44/20		19W	UGR<16	IP20	
4006.02ELC	2700K	1985lm	104lm/W	4006.12ELC	2700K	1806lm	95lm/W	4006.22ELC	2700K	1918lm	101lm/W	4006.32ELC	2700K	1494lm	79lm/W
4006.03ELC	3000K	2067lm	109lm/W	4006.13ELC	3000K	1882lm	99lm/W	4006.23ELC	3000K	1998lm	105lm/W	4006.33ELC	3000K	1556lm	82lm/W
4006.04ELC	4000K	2154lm	113lm/W	4006.14ELC	4000K	1960lm	103lm/W	4006.24ELC	4000K	2081lm	110lm/W	4006.34ELC	4000K	1621lm	85lm/W

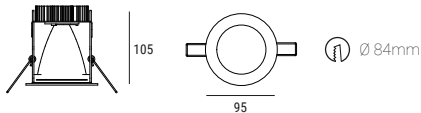

mounting type montaż	ceiling recessed dostropowy
body korpus	steel stal
reflector odbłyśnik	aluminum aluminium
type of source rodzaj źródła	LED
operating temperature range zakres temperatury pracy	from -20°C to +40°C od -20°C do +40°C
lifetime L80B10 żywność L80B10	100 000h
light distribution rozsył światła	symmetrical symetryczny
tolerance of luminous flux tolerancja strumienia świetlnego	+/-10%
colour tolerance tolerancja barwowa SDCM	SDCM<3
nominal voltage napięcie znamionowe	220-240V AC
box karton	200X150X150mm
weight waga	0,3kg

E - electronics/elektronika

L - optics/optyka

C - colours/kolory

0 - on/off
D - DALI
C - Casambi

36 - 36°

03 white
biały06 grey
szary70 anthracite
antracyt05 black
czarny



STAX 95 DEEP				STAX 95 DEEP HONEYCOMB			
12W		UGR<17	IP20	12W		UGR<13	IP20
4007.02ELC	2700K	1007lm	84lm/W	4007.32ELC	2700K	766lm	64lm/W
4007.03ELC	3000K	1049lm	87lm/W	4007.33ELC	3000K	798lm	67lm/W
4007.04ELC	4000K	1093lm	91lm/W	4007.34ELC	4000K	832lm	69lm/W
19W		UGR<19	IP20	19W		UGR<15	IP20
4008.02ELC	2700K	1583lm	83lm/W	4008.32ELC	2700K	1204lm	63lm/W
4008.03ELC	3000K	1649lm	87lm/W	4008.33ELC	3000K	1254lm	66lm/W
4008.04ELC	4000K	1718lm	90lm/W	4008.34ELC	4000K	1307lm	78lm/W

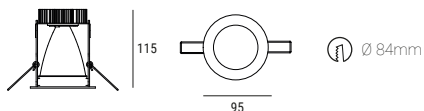

mounting type montaż	ceiling recessed dostropowy
body korpus	steel stal
reflector odbłyśnik	aluminum aluminium
type of source rodzaj źródła	LED
operating temperature range zakres temperatury pracy	from -20°C to +40°C od -20°C do +40°C
lifetime L80B10 żywność L80B10	100 000h
light distribution rozsył światła	symmetrical symetryczny
tolerance of luminous flux tolerancja strumienia świetlnego	+/-10%
colour tolerance tolerancja barwowa SDCM	SDCM<3
nominal voltage napięcie znamionowe	220-240V AC
box karton	200X150X150mm
weight waga	0,3kg

E - electronics/elektronika

L - optics/optyka

C - colours/kolory

0 - on/off
D - DALI
C - Casambi

36 - 36°

03 white
biały06 grey
szary70 anthracite
antracyt05 black
czarny



STAX 100				STAX 100 OPAL GLASS				STAX 100 CLEAR GLASS				STAX 100 HONEYCOMB			
8W	UGR<20		IP20	8W	UGR<26		IP44/20	8W	UGR<20		IP44/20	8W	UGR<14		IP20
4009.02ELC	2700K	895lm	112lm/W	4009.12ELC	2700K	817lm	102lm/W	4009.22ELC	2700K	866lm	108lm/W	4009.32ELC	2700K	594lm	74lm/W
4009.03ELC	3000K	933lm	117lm/W	4009.13ELC	3000K	852lm	107lm/W	4009.23ELC	3000K	902lm	113lm/W	4009.33ELC	3000K	619lm	78lm/W
4009.04ELC	4000K	972lm	122lm/W	4009.14ELC	4000K	887lm	111lm/W	4009.24ELC	4000K	940lm	118lm/W	4009.34ELC	4000K	644lm	81lm/W
13W	UGR<22		IP20	13W	UGR<27		IP44/20	13W	UGR<22		IP44/20	13W	UGR<16		IP20
4010.02ELC	2700K	1500lm	115lm/W	4010.12ELC	2700K	1369lm	105lm/W	4010.22ELC	2700K	1451lm	112lm/W	4010.32ELC	2700K	994lm	76lm/W
4010.03ELC	3000K	1562lm	120lm/W	4010.13ELC	3000K	1426lm	109lm/W	4010.23ELC	3000K	1511lm	117lm/W	4010.33ELC	3000K	1036lm	79lm/W
4010.04ELC	4000K	1627lm	125lm/W	4010.14ELC	4000K	1486lm	114lm/W	4010.24ELC	4000K	1574lm	121lm/W	4010.34ELC	4000K	1079lm	83lm/W

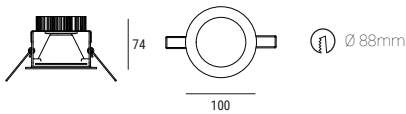

mounting type montaż	ceiling recessed dostropowy
body korpus	steel stal
reflector odbłyśnik	aluminum aluminium
type of source rodzaj źródła	LED
operating temperature range zakres temperatury pracy	from -20°C to +40°C od -20°C do +40°C
lifetime L80B10 żywność L80B10	100 000h
light distribution rozsył światła	symmetrical symetryczny
tolerance of luminous flux tolerancja strumienia świetlnego	+/-10%
colour tolerance tolerancja barwowa SDCM	SDCM<3
nominal voltage napięcie znamionowe	220-240V AC
box karton	250X250X150mm
weight waga	0,3kg

E - electronics/elektronika

L - optics/optyka

C - colours/kolory

0 - on/off
D - DALI
C - Casambi

36 - 36°
60 - 60°

03 white
biały

06 grey
szary

70 anthracite
antracyt

05 black
czarny



STAX 100 DEEP				STAX 100 DEEP HONEYCOMB			
	8W	UGR<15	IP20		8W	UGR<11	IP20
4011.02ELC	2700K	895lm	112lm/W	4011.32ELC	2700K	594lm	74lm/W
4011.03ELC	3000K	933lm	117lm/W	4011.33ELC	3000K	619lm	77lm/W
4011.04ELC	4000K	972lm	122lm/W	4011.34ELC	4000K	644lm	81lm/W
	13W	UGR<17	IP20		13W	UGR<13	IP20
4012.02ELC	2700K	1500lm	115lm/W	4012.32ELC	2700K	994lm	77lm/W
4012.03ELC	3000K	1562lm	120lm/W	4012.33ELC	3000K	1036lm	80lm/W
4012.04ELC	4000K	1627lm	125lm/W	4012.34ELC	4000K	1079lm	83lm/W

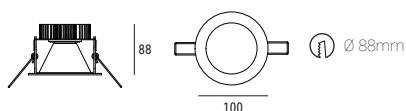

mounting type montaż	ceiling recessed dostropowy
body korpus	steel stal
reflector odbłyśnik	aluminum aluminium
type of source rodzaj źródła	LED
operating temperature range zakres temperatury pracy	from -20°C to +40°C od -20°C do +40°C
lifetime L80B10 żywootność L80B10	100 000h
light distribution rozsył światła	symmetrical symetryczny
tolerance of luminous flux tolerancja strumienia świetlnego	+/-10%
colour tolerance tolerancja barwowa SDCM	SDCM<3
nominal voltage napięcie znamionowe	220-240V AC
box karton	250X250X150mm
weight waga	0,3kg

E - electronics/elektronika

0 - on/off
D - DALI
C - Casambi

L - optics/optyka

36 - 36°
60 - 60°

C - colours/kolory

03

white
biały

06

grey
szary

70

anthracite
antracyt

05

black
czarny



STAX 140				STAX 140 OPAL GLASS				STAX 140 CLEAR GLASS				STAX 140 HONEYCOMB			
12W	UGR<20	IP20		12W	UGR<25	IP44/20		12W	UGR<20	IP44/20		12W	UGR<16	IP20	
4013.02ELC	2700K	1553lm	129lm/W	4013.12ELC	2700K	1403lm	117lm/W	4013.22ELC	2700K	1503lm	125lm/W	4013.32ELC	2700K	1086lm	90lm/W
4013.03ELC	3000K	1618lm	135lm/W	4013.13ELC	3000K	1462lm	122lm/W	4013.23ELC	3000K	1566lm	131lm/W	4013.33ELC	3000K	1131lm	94lm/W
4013.04ELC	4000K	1686lm	141lm/W	4013.14ELC	4000K	1523lm	127lm/W	4013.24ELC	4000K	1632lm	136lm/W	4013.34ELC	4000K	1178lm	98lm/W
18W	UGR<21	IP20		18W	UGR<26	IP44/20		18W	UGR<21	IP44/20		18W	UGR<17	IP20	
4014.02ELC	2700K	2159lm	120lm/W	4014.12ELC	2700K	1950lm	108lm/W	4014.22ELC	2700K	2089lm	116lm/W	4014.32ELC	2700K	1509lm	84lm/W
4014.03ELC	3000K	2249lm	125lm/W	4014.13ELC	3000K	2031lm	113lm/W	4014.23ELC	3000K	2176lm	121lm/W	4014.33ELC	3000K	1572lm	87lm/W
4014.04ELC	4000K	2343lm	130lm/W	4014.14ELC	4000K	2116lm	118lm/W	4014.24ELC	4000K	2267lm	126lm/W	4014.34ELC	4000K	1637lm	91lm/W
27W	UGR<22	IP20		27W	UGR<27	IP44/20		27W	UGR<22	IP44/20		27W	UGR<18	IP20	
4015.02ELC	2700K	2917lm	108lm/W	4015.12ELC	2700K	2635lm	98lm/W	4015.22ELC	2700K	2823lm	105lm/W	4015.32ELC	2700K	2039lm	76lm/W
4015.03ELC	3000K	3039lm	113lm/W	4015.13ELC	3000K	2745lm	102lm/W	4015.23ELC	3000K	2941lm	109lm/W	4015.33ELC	3000K	2124lm	78lm/W
4015.04ELC	4000K	3166lm	117lm/W	4015.14ELC	4000K	2859lm	106lm/W	4015.24ELC	4000K	3064lm	113lm/W	4015.34ELC	4000K	2213lm	82lm/W

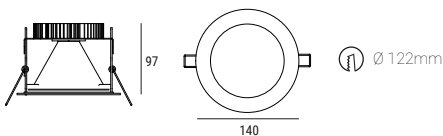

mounting type montaż	ceiling recessed dostropowy
body korpus	steel stal
reflector odbłyśnik	aluminum aluminium
type of source rodzaj źródła	LED
operating temperature range zakres temperatury pracy	from -20°C to +40°C od -20°C do +40°C
lifetime L80B10 żywność L80B10	100 000h
light distribution rozsył światła	symmetrical symetryczny
tolerance of luminous flux tolerancja strumienia świetlnego	+/-10%
colour tolerance tolerancja barwowa SDCM	SDCM<3
nominal voltage napięcie znamionowe	220-240V AC
box karton	250X250X150mm
weight waga	0,5kg

E - electronics/elektronika

L - optics/optyka

C - colours/kolory

0 - on/off
D - DALI
C - Casambi

36 - 36°
60 - 60°

03 white
biały

06 grey
szary

70 anthracite
antracyt

05 black
czarny



STAX 140 DEEP			
	12W	UGR<17	IP20
4016.02ELC	2700K	1269lm	106lm/W
4016.03ELC	3000K	1322m	110lm/W
4016.04ELC	4000K	1378lm	115m/W
	18W	UGR<18	IP20
4017.02ELC	2700K	1764lm	98lm/W
4017.03ELC	3000K	1838lm	102lm/W
4017.04ELC	4000K	1914lm	106lm/W
	27W	UGR<19	IP20
4018.02ELC	2700K	2384lm	88lm/W
4018.03ELC	3000K	2484lm	82lm/W
4018.04ELC	4000K	2587lm	86lm/W

STAX 140 DEEP HONEYCOMB			
	12W	UGR<13	IP20
4016.32ELC	2700K	919lm	77lm/W
4016.33ELC	3000K	957lm	80lm/W
4016.34ELC	4000K	997lm	83lm/W
	18W	UGR<14	IP20
4017.32ELC	2700K	1277lm	71lm/W
4017.33ELC	3000K	1330lm	74lm/W
4017.34ELC	4000K	1385lm	77lm/W
	27W	UGR<15	IP20
4018.32ELC	2700K	1725lm	67lm/W
4018.33ELC	3000K	1797lm	68lm/W
4018.34ELC	4000K	1872lm	69lm/W

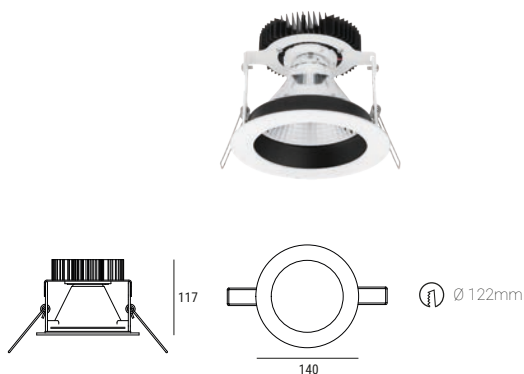

mounting type montaż	ceiling recessed dostropowy
body korpus	steel stal
reflector odbłyśnik	aluminum aluminium
type of source rodzaj źródła	LED
operating temperature range zakres temperatury pracy	from -20°C to +40°C od -20°C do +40°C
lifetime L80B10 żywość L80B10	100 000h
light distribution rozsył światła	symmetrical symetryczny
tolerance of luminous flux tolerancja strumienia świetlnego	+/-10%
colour tolerance tolerancja barwowa SDCM	SDCM<3
nominal voltage napięcie znamionowe	220-240V AC
box karton	250X250X150mm
weight waga	0,5kg

E - electronics/elektronika

L - optics/optyka

C - colours/kolory

0 - on/off
D - DALI
C - Casambi

36 - 36°
60 - 60°

03 white
biały

06 grey
szary

70 anthracite
antracyt

05 black
czarny



STAX 180				STAX 180 OPAL GLASS				STAX 180 CLEAR GLASS				STAX 180 HONEYCOMB			
25W	UGR<21	IP20		25W	UGR<27	IP44/20		25W	UGR<21	IP44/20		25W	UGR<19	IP20	
4019.02ELC	2700K	3170lm	127lm/W	4019.12ELC	2700K	3037lm	121lm/W	4019.22ELC	2700K	3070lm	123lm/W	4019.32ELC	2700K	2202lm	88lm/W
4019.03ELC	3000K	3302lm	133lm/W	4019.13ELC	3000K	3163lm	126lm/W	4019.23ELC	3000K	3198lm	128lm/W	4019.33ELC	3000K	2294lm	92lm/W
4019.04ELC	4000K	3440lm	138lm/W	4019.14ELC	4000K	3295lm	131lm/W	4019.24ELC	4000K	3331lm	133lm/W	4019.34ELC	4000K	2390lm	96lm/W
39W	UGR<22	IP20		39W	UGR<28	IP44/20		39W	UGR<22	IP44/20		39W	UGR<20	IP20	
4020.02ELC	2700K	4551lm	117lm/W	4020.12ELC	2700K	4359lm	112lm/W	4020.22ELC	2700K	4407m	113lm/W	4020.32ELC	2700K	3161lm	80lm/W
4020.03ELC	3000K	4741lm	122lm/W	4020.13ELC	3000K	4541lm	117lm/W	4020.23ELC	3000K	4591lm	118lm/W	4020.33ELC	3000K	3293lm	84lm/W
4020.04ELC	4000K	4938lm	127lm/W	4020.14ELC	4000K	4730lm	121lm/W	4020.24ELC	4000K	4782lm	123lm/W	4020.34ELC	4000K	3431lm	88lm/W

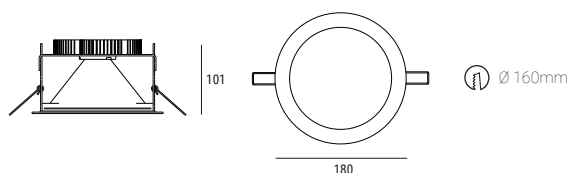

mounting type montaż	ceiling recessed dostropowy
body korpus	steel stal
reflector odbłyśnik	aluminum aluminium
type of source rodzaj źródła	LED
operating temperature range zakres temperatury pracy	from -20°C to +40°C od -20°C do +40°C
lifetime L80B10 żywność L80B10	100 000h
light distribution rozsył światła	symmetrical symetryczny
tolerance of luminous flux tolerancja strumienia świetlnego	+/-10%
colour tolerance tolerancja barwowa SDCM	SDCM<3
nominal voltage napięcie znamionowe	220-240V AC
box karton	250X250X150mm
weigh waga	0,7kg

E - electronics/elektronika

L - optics/optyka

C - colours/kolory

0 - on/off
D - DALI
C - Casambi

60 - 60°

03 white
biały06 grey
szary70 anthracite
antracyt05 black
czarny



STAX 180 DEEP				STAX 180 DEEP HONEYCOMB			
	25W	UGR<21	IP20		25W	UGR<18	IP20
4021.02ELC	2700K	3103lm	124lm/W	4021.32ELC	2700K	2069lm	83lm/W
4021.03ELC	3000K	3233lm	130lm/W	4021.33ELC	3000K	2155lm	87lm/W
4021.04ELC	4000K	3368lm	135lm/W	4021.34ELC	4000K	2245lm	90lm/W
	39W	UGR<22	IP20		39W	UGR<19	IP20
4022.02ELC	2700K	4455lm	114lm/W	4022.32ELC	2700K	2970lm	76lm/W
4022.03ELC	3000K	4641lm	119lm/W	4022.33ELC	3000K	3094lm	80lm/W
4022.04ELC	4000K	4834lm	124lm/W	4022.34ELC	4000K	3223lm	83lm/W

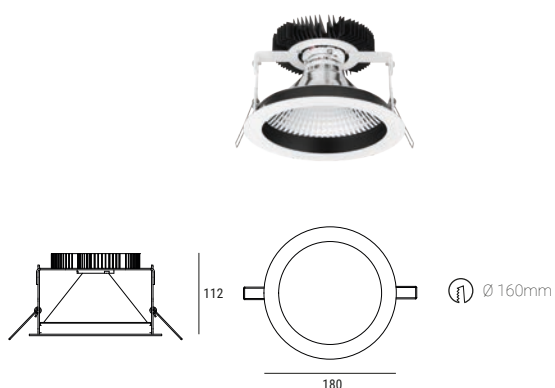

mounting type montaż	ceiling recessed dostropowy
body korpus	steel stal
reflector odbłyśnik	aluminum aluminium
type of source rodzaj źródła	LED
operating temperature range zakres temperatury pracy	from -20°C to +40°C od -20°C do +40°C
lifetime L80B10 żywołność L80B10	100 000h
light distribution rozsył światła	symmetrical symetryczny
tolerance of luminous flux tolerancja strumienia świetlnego	+/-10%
colour tolerance tolerancja barwowa SDCM	SDCM<3
nominal voltage napięcie znamionowe	220-240V AC
box karton	250X250X150mm
weight waga	0,7kg

E - electronics/elektronika

0 - on/off
D - DALI
C - Casambi

L - optics/optyka

60 - 60°

C - colours/kolory

03 white
biały

06 grey
szary

70 anthracite
antracyt

05 black
czarny

STAX 250

IP20 IP44 CRI>90 



STAX 250				STAX 250 OPAL GLASS				STAX 250 CLEAR GLASS				STAX 250 HONEYCOMB			
39W	UGR<22	IP20		39W	UGR<26	IP44/20		39W	UGR<22	IP44/20		39W	UGR<20	IP20	
4023.02ELC	2700K	4551lm	117lm/W	4023.12ELC	2700K	4359lm	112lm/W	4023.22ELC	2700K	4407lm	113lm/W	4023.32ELC	2700K	3018lm	77lm/W
4023.03ELC	3000K	4741lm	122lm/W	4023.13ELC	3000K	4541lm	117lm/W	4023.23ELC	3000K	4591lm	118lm/W	4023.33ELC	3000K	3144lm	81lm/W
4023.04ELC	4000K	4938lm	127lm/W	4023.14ELC	4000K	4730lm	121lm/W	4023.24ELC	4000K	4782lm	123lm/W	4023.34ELC	4000K	3275lm	84lm/W
50W	UGR<23	IP20		50W	UGR<27	IP44/20		50W	UGR<23	IP44/20		50W	UGR<20	IP20	
4024.02ELC	2700K	5465lm	109lm/W	4024.12ELC	2700K	5235lm	105lm/W	4024.22ELC	2700K	5293lm	106lm/W	4024.32ELC	2700K	3624lm	72lm/W
4024.03ELC	3000K	5693lm	114lm/W	4024.13ELC	3000K	5454lm	110lm/W	4024.23ELC	3000K	5514lm	111lm/W	4024.33ELC	3000K	3776lm	76lm/W
4024.04ELC	4000K	5931lm	119lm/W	4024.14ELC	4000K	5681lm	114lm/W	4024.24ELC	4000K	5744lm	116lm/W	4024.34ELC	4000K	3933lm	79lm/W

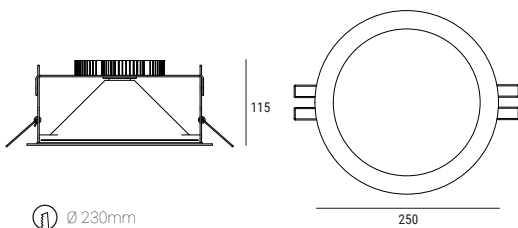

 Ø 230mm

250

mounting type montaż	ceiling recessed dostropowy
body korpus	steel stal
reflector odbłyśnik	aluminum aluminium
type of source rodzaj źródła	LED
operating temperature range zakres temperatury pracy	from -20°C to +40°C od -20°C do +40°C
lifetime L80B10 żywność L80B10	100 000h
light distribution rozsył światła	symmetrical symetryczny
tolerance of luminous flux tolerancja strumienia świetlnego	+/-10%
colour tolerance tolerancja barwowa SDCM	SDCM<3
nominal voltage napięcie znamionowe	220-240V AC
box karton	300X380X200mm
weight waga	1,3kg

E - electronics/elektronika

L - optics/optyka

C - colours/kolory

0 - on/off
D - DALI
C - Casambi

85 - 85°

03 white
biały

06 grey
szary

70 anthracite
antracyt

05 black
czarny

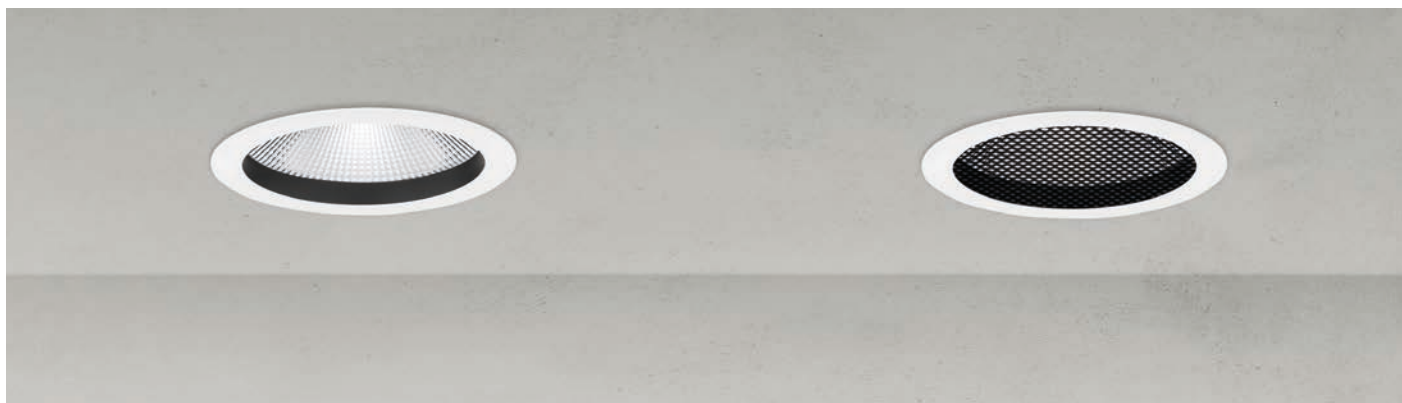

STAX 250 DEEP			
	39W	UGR<21	IP20
4025.02ELC	2700K	4407lm	113lm/W
4025.03ELC	3000K	4591lm	118lm/W
4025.04ELC	4000K	4782lm	123lm/W
	50W	UGR<22	IP20
4026.02ELC	2700K	5293lm	106lm/W
4026.03ELC	3000K	5514lm	110lm/W
4026.04ELC	4000K	5744lm	115lm/W

STAX 250 DEEP HONEYCOMB			
	39W	UGR<19	IP20
4025.32ELC	2700K	2826lm	72lm/W
4025.33ELC	3000K	2944lm	76lm/W
4025.34ELC	4000K	3067lm	79lm/W
	50W	UGR<19	IP20
4026.32ELC	2700K	3394lm	68lm/W
4026.33ELC	3000K	3536lm	71lm/W
4026.34ELC	4000K	3683lm	74lm/W

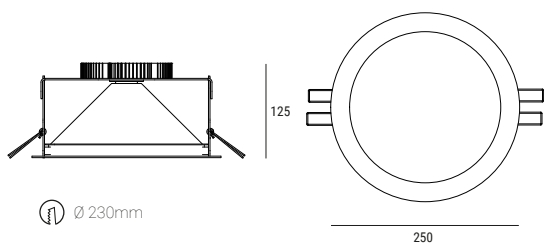

mounting type montaż	ceiling recessed dostropowy
body korpus	steel stal
reflector odbłyśnik	aluminum aluminium
type of source rodzaj źródła	LED
operating temperature range zakres temperatury pracy	from -20°C to +40°C od -20°C do +40°C
lifetime L80B10 żywołność L80B10	100 000h
light distribution rozsył światła	symmetrical symetryczny
tolerance of luminous flux tolerancja strumienia świetlnego	+/-10%
colour tolerance tolerancja barwowa SDCM	SDCM<3
nominal voltage napięcie znamionowe	220-240V AC
box karton	300X380X200mm
weight waga	1,3kg

E - electronics/elektronika

L - optics/optyka

C - colours/kolory

0 - on/off
D - DALI
C - Casambi

85 - 85°

03 white
biały

06 grey
szary

70 anthracite
antracyt

05 black
czarny

Lux is an effective, versatile downlight. In a harmonious and aesthetic way, they fill a clean space on the ceiling. A specially designed optical system ensures even light distribution without a point effect. Equipping the luminaire with functional apertures increases its light parameters. The luminaires provide luminance control at the UGR<13 level for selected options, which ensures comfortable lighting solutions. Thanks to the above-mentioned factors, the areas of application of luminaires from commercial and service facilities, communication routes, guesthouses and hotels as well as residential apartments have been increased.

LUX WHITE



LUX 135 WHITE
opal



LUX 135 WHITE
microprism



LUX 135 WHITE
microprism honeycomb



LUX 135 WHITE
lens

Lux to efektywne, wszechstronne oświetlenie typu downlight. W sposób harmonijny i estetyczny wypełniają czystą przestrzeń na suficie. Specjalnie zaprojektowany układ optyczny zapewnia równomierny rozsył światła bez efektu punktowego. Wyposażenie oprawy w funkcjonalne przesłony zwiększają jej parametry świetlne. Oprawy zapewniają kontrolę luminancji na poziomie $UGR < 13$ dla wybranych opcji co zapewnia komfortowe rozwiązania oświetleniowe. Dzięki w/w czynnikom zwiększone zostały obszary zastosowania opraw od obiektów handlowo- usługowych, ciągi komunikacyjne, pensjonaty i hotele jak również apartamenty mieszkalne.

LUX BLACK



LUX 135 BLACK
opal



LUX 135 BLACK
microprism



LUX 135 BLACK
microprism honeycomb



LUX 135 BLACK
lens



opal

microprism

honeycomb

lens



LUX 135 WHITE - OPAL				LUX 135 WHITE - MICROPRISM				LUX 135 WHITE MICROPRISM HONEYCOMB			
7W	UGR<20	IP44		7W	UGR<19	IP44		7W	UGR<14	IP44	
4027.42EL	2700K	511lm	73lm/W	4027.52EL	2700K	518lm	74lm/W	4027.62EL	2700K	192lm	27lm/W
4027.43EL	3000K	532lm	76lm/W	4027.53EL	3000K	540lm	77lm/W	4027.63EL	3000K	200lm	29lm/W
4027.44EL	4000K	554lm	79lm/W	4027.54EL	4000K	562lm	80lm/W	4027.64EL	4000K	209lm	30lm/W
15W	UGR<23	IP44		15W	UGR<22	IP44		15W	UGR<16	IP44	
4028.42EL	2700K	1124lm	75lm/W	4028.52EL	2700K	1140lm	76lm/W	4028.62EL	2700K	424lm	28lm/W
4028.43EL	3000K	1171lm	78lm/W	4028.53EL	3000K	1188lm	80lm/W	4028.63EL	3000K	441lm	30lm/W
4028.44EL	4000K	1220lm	81lm/W	4028.54EL	4000K	1238lm	83lm/W	4028.64EL	4000K	460lm	31lm/W
19W	UGR<24	IP44		19W	UGR<23	IP44		19W	UGR<17	IP44	
4029.42EL	2700K	1539lm	81lm/W	4029.52EL	2700K	1561lm	82lm/W	4029.62EL	2700K	580lm	31lm/W
4029.43EL	3000K	1603lm	84lm/W	4029.53EL	3000K	1626lm	86lm/W	4029.63EL	3000K	604lm	32lm/W
4029.44EL	4000K	1670lm	88lm/W	4029.54EL	4000K	1694lm	89lm/W	4029.64EL	4000K	629lm	33lm/W



mounting type montaż	ceiling recessed dostropowy
body korpus	aluminum aluminium
reflector odbłyśnik	aluminum aluminium
type of source rodzaj źródła	LED
operating temperature range zakres temperatury pracy	from -20°C to +40°C od -20°C do +40°C
lifetime L80B10 żywność L80B10	100 000h
light distribution rozsył światła	symmetrical symetryczny
tolerance of luminous flux tolerancja strumienia świetlnego	+/-10%
colour tolerance tolerancja barwowa SDCM	SDCM<3
nominal voltage napięcie znamionowe	220-240V AC
box karton	250X250X150mm
weight waga	0,2kg

E - electronics/elektronika

L - optics/optyka

0 - on/off

D - DALI

C - Casambi

90 - 90°



LUX 135 BLACK OPAL				LUX 135 BLACK MICROPRISM				LUX 135 BLACK MICROPRISM HONEYCOMB			
7W	UGR<19	IP44		7W	UGR<17	IP44		7W	UGR<13	IP44	
4030.42EL	2700K	326lm	47lm/W	4030.52EL	2700K	340lm	49lm/W	4030.62EL	2700K	170lm	24lm/W
4030.43EL	3000K	339lm	49lm/W	4030.53EL	3000K	355lm	51lm/W	4030.63EL	3000K	177lm	25lm/W
4030.44EL	4000K	353lm	50lm/W	4030.54EL	4000K	369lm	53lm/W	4030.64EL	4000K	185lm	30lm/W
15W	UGR<21	IP44		15W	UGR<20	IP44		15W	UGR<16	IP44	
4031.42EL	2700K	717lm	48lm/W	4031.52EL	2700K	749lm	50lm/W	4031.62EL	2700K	375lm	25lm/W
4031.43EL	3000K	747lm	50lm/W	4031.53EL	3000K	781lm	52lm/W	4031.63EL	3000K	390lm	26lm/W
4031.44EL	4000K	778lm	52lm/W	4031.54EL	4000K	813lm	52lm/W	4031.64EL	4000K	407lm	27lm/W
19W	UGR<22	IP44		19W	UGR<21	IP44		19W	UGR<17	IP44	
4032.42EL	2700K	981lm	52lm/W	4032.52EL	2700K	1026lm	54lm/W	4032.62EL	2700K	513lm	27lm/W
4032.43EL	3000K	1022lm	54lm/W	4032.53EL	3000K	1069lm	57lm/W	4032.63EL	3000K	534lm	28lm/W
4032.44EL	4000K	1065lm	56lm/W	4032.54EL	4000K	1113lm	59lm/W	4032.64EL	4000K	557lm	29lm/W

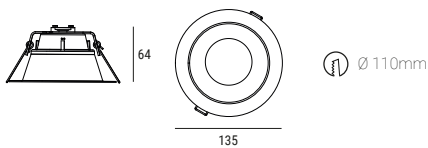

mounting type montaż	ceiling recessed dostropowy
body korpus	aluminum aluminium
reflector odbłyśnik	aluminum aluminium
type of source rodzaj źródła	LED
operating temperature range zakres temperatury pracy	from -20°C to +40°C od -20°C do +40°C
lifetime L80B10 żywołność L80B10	100 000h
light distribution rozsył światła	symmetrical symetryczny
tolerance of luminous flux tolerancja strumienia świetlnego	+/-10%
colour tolerance tolerancja barwowa SDCM	SDCM<3
nominal voltage napięcie znamionowe	220-240V AC
box karton	250X250X150mm
weighth waga	0,2kg

E - electronics/elektronika

L - optics/optyka

0 - on/off
D - DALI
C - Casambi

90 - 90°

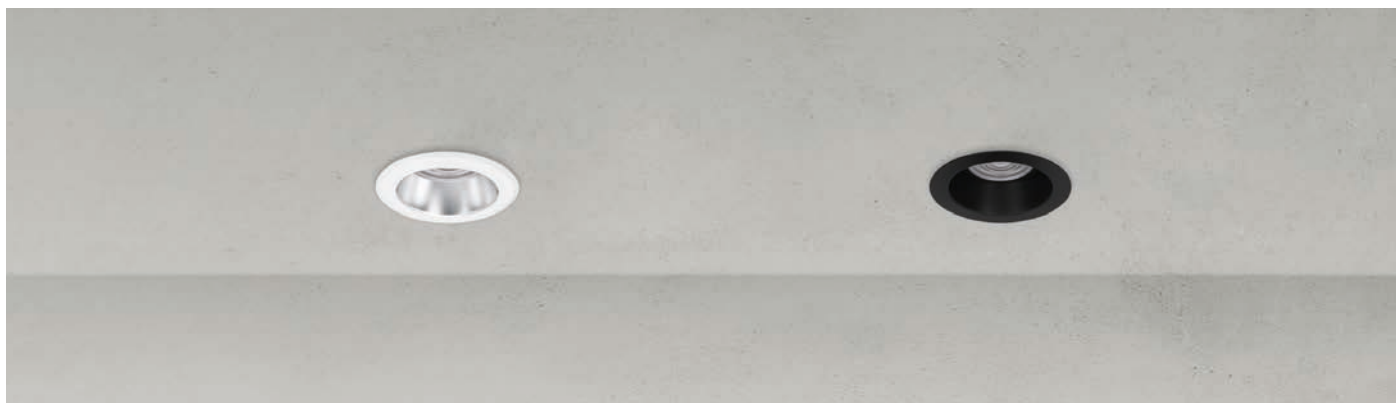

LUX 135 WHITE - LENS				LUX 135 BLACK - LENS			
	7W	UGR<17	IP44		7W	UGR<15	IP44
4027.02EL	2700K	577lm	82lm/W	4030.02EL	2700K	592lm	85lm/W
4027.03EL	3000K	601lm	87lm/W	4030.03EL	3000K	617lm	89lm/W
4027.04EL	4000K	626lm	89lm/W	4030.04EL	4000K	642lm	92lm/W
	15W	UGR<19	IP44		15W	UGR<18	IP44
4028.02EL	2700K	1271lm	85lm/W	4031.02EL	2700K	1303lm	87lm/W
4028.03EL	3000K	1324lm	89lm/W	4031.03EL	3000K	1358lm	91lm/W
4028.04EL	4000K	1379lm	92lm/W	4031.04EL	4000K	1414lm	94lm/W
	19W	UGR<20	IP44		19W	UGR<19	IP44
4029.02EL	2700K	1739lm	91lm/W	4032.02EL	2700K	1784lm	94lm/W
4029.03EL	3000K	1812lm	95lm/W	4032.03EL	3000K	1858lm	98lm/W
4029.04EL	4000K	1888lm	99lm/W	4032.04EL	4000K	1936lm	102lm/W

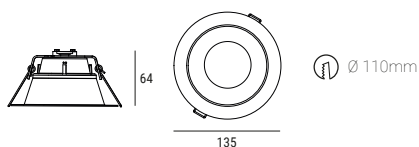

mounting type montaż	ceiling recessed dostropowy
body korpus	aluminum aluminium
reflector odbłyśnik	aluminum aluminium
type of source rodzaj źródła	LED
operating temperature range zakres temperatury pracy	from -20°C to +40°C od -20°C do +40°C
lifetime L80B10 żywność L80B10	100 000h
light distribution rozsył światła	symmetrical symetryczny
tolerance of luminous flux tolerancja strumienia świetlnego	+/-10%
colour tolerance tolerancja barwowa SDCM	SDCM<3
nominal voltage napięcie znamionowe	220-240V AC
box karton	250X250X150mm
weight waga	0,2kg

E - electronics/elektronika

L - optics/optyka

0 - on/off

D - DALI

C - Casambi

36 - 36°

60 - 60°



LUX 190 WHITE OPAL				LUX 190 WHITE MICROPRISM				LUX 190 WHITE MICROPRISM HONEYCOMB			
12W	UGR<23	IP44		12W	UGR<21	IP44		12W	UGR<17	IP44	
4033.42EL	2700K	1503lm	125lm/W	4033.52EL	2700K	1470lm	123lm/W	4033.62EL	2700K	701lm	58lm/W
4033.43EL	3000K	1566lm	131lm/W	4033.53EL	3000K	1531lm	128lm/W	4033.63EL	3000K	731lm	61lm/W
4033.44EL	4000K	1632lm	136lm/W	4033.54EL	4000K	1595lm	133lm/W	4033.64EL	4000K	761lm	63lm/W
18W	UGR<24	IP44		18W	UGR<22	IP44		18W	UGR<18	IP44	
4034.42EL	2700K	2089lm	116lm/W	4034.52EL	2700K	2042lm	113lm/W	4034.62EL	2700K	975lm	54lm/W
4034.43EL	3000K	2176lm	121lm/W	4034.53EL	3000K	2128lm	119lm/W	4034.63EL	3000K	1016lm	56lm/W
4034.44EL	4000K	2267lm	126lm/W	4034.54EL	4000K	2217lm	123lm/W	4034.64EL	4000K	1058lm	59lm/W
27W	UGR<25	IP44		27W	UGR<23	IP44		27W	UGR<19	IP44	
4035.42EL	2700K	2823lm	105lm/W	4035.52EL	2700K	2761lm	102lm/W	4035.62EL	2700K	1318lm	49lm/W
4035.43EL	3000K	2941lm	109lm/W	4035.53EL	3000K	2876lm	106lm/W	4035.63EL	3000K	1373lm	51lm/W
4035.44EL	4000K	3064lm	113lm/W	4035.54EL	4000K	2996lm	111lm/W	4035.64EL	4000K	1430lm	53lm/W



mounting type montaż	ceiling recessed dostropowy
body korpus	aluminum aluminium
reflector odbłyśnik	aluminum aluminium
type of source rodzaj źródła	LED
operating temperature range zakres temperatury pracy	from -20°C to +40°C od -20°C do +40°C
lifetime L80B10 żywołność L80B10	100 000h
light distribution rozsył światła	symmetrical symetryczny
tolerance of luminous flux tolerancja strumienia świetlnego	+/-10%
colour tolerance tolerancja barwowa SDCM	SDCM<3
nominal voltage napięcie znamionowe	220-240V AC
box karton	250X250X150mm
weight waga	0,3kg

E - electronics/elektronika

L - optics/optyka

0 - on/off
D - DALI
C - Casambi

90 - 90°



COMET 85

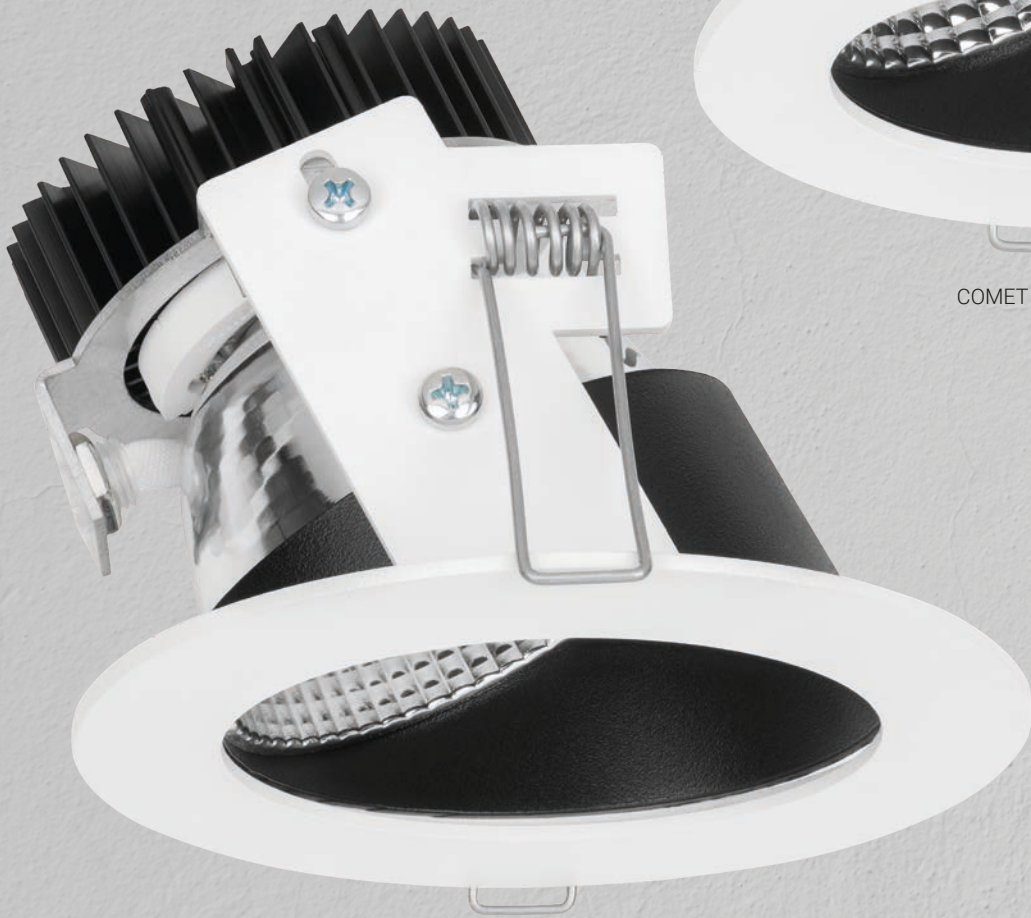

COMET 120

COMET

Comet is a series of downlights, additionally equipped with a wallwasher reflector. The use of this type of optical system allows precise directing of the light beam and illumination of the illuminated space, e.g. a wall. It is possible to choose a 36/60 degree beam angle.

Comet to seria opraw typu downlight, dodatkowo wyposażona w odbłyśnik typu wallwasher. Zastosowanie tego rodzaju układu optycznego umożliwia precyzyjne skierowanie wiązki światła i doświetlenie oświetlanej przestrzeni np. ściany. Istnieje możliwość wyboru kąta wiązki 36/60 stopni.



COMET 85			
6W		IP20	
4036.02ELC	2700K	447lm	75lm/W
4036.03ELC	3000K	465lm	79lm/W
4036.04ELC	4000K	484lm	81lm/W
10W		IP20	
4037.02ELC	2700K	712lm	71lm/W
4037.03ELC	3000K	741lm	74lm/W
4037.04ELC	4000K	772lm	77lm/W

COMET 120			
8W		IP20	
4038.02ELC	2700K	652lm	82lm/W
4038.03ELC	3000K	679lm	86lm/W
4038.04ELC	4000K	708lm	89lm/W
13W		IP20	
4039.02ELC	2700K	1092lm	84lm/W
4039.03ELC	3000K	1138lm	88lm/W
4039.04ELC	4000K	1185lm	91lm/W

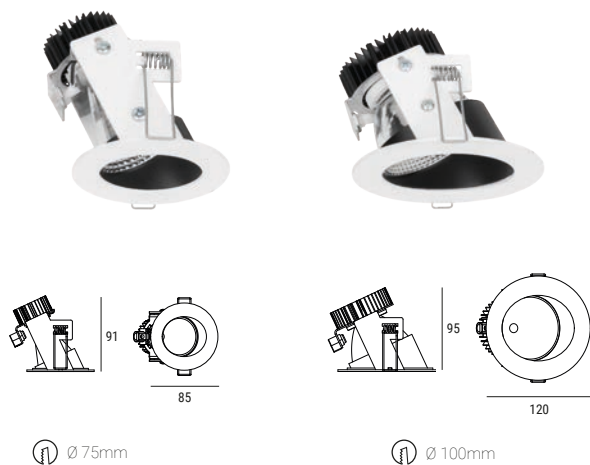

mounting type montaż	ceiling recessed dostropowy
body korpus	steel stal
reflector odbłyśnik	aluminum aluminium
type of source rodzaj źródła	LED
operating temperature range zakres temperatury pracy	from -20°C to +40°C od -20°C do +40°C
lifetime L80B10 żywołność L80B10	100 000h
light distribution rozsył światła	asymmetrical asymetryczny
tolerance of luminous flux tolerancja strumienia świetlnego	+/-10%
colour tolerance tolerancja barwowa SDCM	SDCM<3
nominal voltage napięcie znamionowe	220-240V AC
box karton	200X150X150mm
weight waga	Ø85- 0,2kg Ø120- 0,4kg

E - electronics/elektronika

- 0 - on/off
- D - DALI
- C - Casambi

L - optics/optyka

- Ø85 Ø120
- 36 - 36° 36 - 36°
- 60 - 60°

C - colours/kolory

- 03 white
biały
- 06 grey
szary
- 70 anthracite
antracyt
- 05 black
czarny





installation of the luminaire body
without visible fixings

montaż korpusu oprawy
bez widocznych mocowań

SPIN

Spin is a series of surface-mounted luminaires with a simple appearance, thanks to which they become an aesthetic architectural element of the designed space. They are ideal for installation on ceilings where it is not possible to use recessed luminaires. Luminaires available in three diameters (120mm, 160mm, 230mm), using high-quality LEDs and an efficient aluminum reflector. In addition, the luminaires can be hung by adding hangers. Spin is an excellent solution for lighting shops, communication routes, office buildings and residential buildings.

Spin to seria opraw natynkowych o prostym wyglądzie dzięki czemu stają się estetycznym elementem architektonicznym projektowanej przestrzeni. Idealnie nadają się do montażu na sufitach, w których nie ma możliwości zastosowania opraw wpuszczanych. Oprawy dostępne w trzech średnicach (120mm, 160mm, 230mm), wykorzystujące wysokiej jakości diody LED oraz wydajny aluminiowy reflektor. Dodatkowo oprawy możemy zwiesić dodając zwieszaki. Spin to doskonałe rozwiązanie dla oświetlenia sklepów, ciągów komunikacyjnych, obiektów biurowych oraz obiektów mieszkalnych.



SPIN 120			
12W	UGR<20	IP20	
4040.02ELC	2700K	1553lm	129lm/W
4040.03ELC	3000K	1618lm	135lm/W
4040.04ELC	4000K	1686lm	141lm/W
18W	UGR<21	IP20	
4041.02ELC	2700K	2159lm	120lm/W
4041.03ELC	3000K	2249lm	125lm/W
4041.04ELC	4000K	2343lm	130lm/W

SPIN 160			
25W	UGR<21	IP20	
4042.02ELC	2700K	3170lm	127lm/W
4042.03ELC	3000K	3302lm	132lm/W
4042.04ELC	4000K	3440lm	138lm/W

SPIN 230			
39W	UGR<22	IP20	
4043.02ELC	2700K	4551lm	117lm/W
4043.03ELC	3000K	4741lm	122lm/W
4043.04ELC	4000K	4938lm	127lm/W

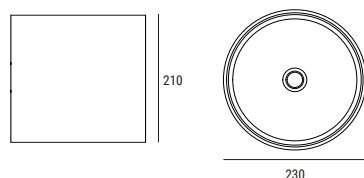
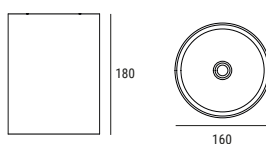
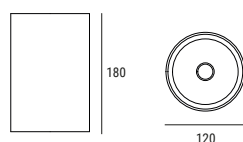

mounting type montaż	ceiling recessed dostropowy
body korpus	aluminium aluminium
reflector odbłyśnik	aluminium aluminium
type of source rodzaj źródła	LED
operating temperature range zakres temperatury pracy	from -20°C to +40°C od -20°C do +40°C
lifetime L80B10 żywoćność L80B10	100 000h
light distribution rozsył światła	symmetrical symetryczny
tolerance of luminous flux tolerancja strumienia świetlnego	+/-10%
colour tolerance tolerancja barwowa SDCM	SDCM<3
nominal voltage napięcie znamionowe	220-240V AC
box karton	Ø120 - 250x250x150mm Ø160 - 300x380x200mm Ø230 - 400x400x280mm
weigh waga	Ø120 - 1,2kg Ø160 - 1,8kg Ø230 - 3,5kg

hanging adapter/adapter do zwieszania

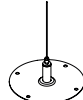
	Ø120	Ø160	Ø230
	40.01 - 1000mm 40.02 - 4000mm	40.03 - 1000mm 40.04 - 4000mm	40.05 - 1000mm 40.06 - 4000mm

E - electronics/elektronika

L - optics/optyka

C - colours/kolory

0 - on/off
D - DALI
C - Casambi

Ø120 Ø160 Ø230
36 - 36° 60 - 60° 90 - 90°
60 - 60°

03 white
biały 06 grey
szary 70 anthracite
antracyt 05 black
czarny

We reserve the right to withdraw and change products from the catalogue at any time without prior notice. The colour options presented in the catalogue may differ from the actual ones. Technical parameters are subject to change.

Zastrzegamy prawo do wycofania produktów z katalogu lub zmian, w każdej chwili i bez wcześniejszego poinformowania. Opcje kolorystyczne wykończenia przedstawione w katalogu mogą różnić się od rzeczywistych. Parametry techniczne mogą ulec zmianie.



liralighting.pl