

GV6-200 series

200W Waterproof Constant Voltage LED Driver



Features:

- European AC input voltage: 176-264VAC
- Constant voltage design
- Built-in active PFC function (PF > 0.97)
- Protections: Short Circuit / Over Current / Over Temperature / Input Under Voltage
- Cooling by free air convection
- Surge immunity: Differential Mode - 6kV, Common Mode - 10kV
- IP67 design for indoor and outdoor applications
- Suitable for dry/damp/wet locations

Application:

- Landscape Lighting



DESCRIPTION

The GV6-200 series is constant voltage led driver, designed for lighting used for landscape illumination. The driver has built-in active PFC, multiple protections, and 10KV surge immunity. It's an excellent design with high reliability and long lifetime.

MODEL INFORMATION

MODEL NUMBER	OUTPUT POWER [W]	OUTPUT VOLTAGE [VDC]	OUTPUT CURRENT RANGE [A]	TYPICAL EFFICIENCY	TYPICAL PF	TYPICAL THD
GV6-200B024	200	24	0 ÷ 8.40	93%	0.98	5%
GV6-200B036	200	36	0 ÷ 5.60	94%	0.98	5%

Notes:

1. All performance parameters are measured at 25°C ambient temperature, 230VAC input, full load conditions if no specific note.

INPUT SPECIFICATIONS

Parameter	Min.		Typ.		Max.		Notes		
INPUT VOLTAGE	176VAC		200 ÷ 240VAC		264VAC		-		
INPUT FREQUENCY	47Hz		50/60Hz		63Hz		-		
LEAKAGE CURRENT	-		-		0.7mA		240VAC/60Hz		
INPUT AC CURRENT	-		-		1.3A		220-240VAC, full load		
INRUSH CURRENT	-		-		75A		230VAC, full load, Cold start		
POWER FACTOR	0.97		0.99		-		230VAC, 50-60Hz, full load		
	0.95		0.97		-		230VAC, 50-60Hz, 75% load		
	0.92		0.95		-		230VAC, 50-60Hz, 50% load		
THD	-		-		10%		220-240VAC, 50-60Hz, 50-100% load		
MAX. NO. OF PSU ON CIRCUIT BREAKER	B10	C10	B16	C16	B20	C20	B25	C25	230VAC
	2	4	4	6	5	8	6	10	

GV6-200 series

200W Waterproof Constant Voltage LED Driver



OUTPUT SPECIFICATIONS

Parameter	Min.	Typ.	Max.	Notes
OUTPUT VOLTAGE TOLERANCE	-2%	-	+2%	-
TOTAL OUTPUT CURRENT RIPPLE (PK-PK)	-2%	-	+2%	Full load, measured by 20MHz bandwidth oscilloscope and the output paralleled a 0.1μF ceramic capacitor and 47μF electrolytic capacitor
TURN-ON VOLTAGE OVERSHOOT	-5%	-	+5%	220-240VAC, full load
LINE REGULATION	-0.5%	-	+0.5%	25°C ± 10°C ambient temperature, input voltage changes from 200VAC to 240VAC
LOAD REGULATION	-1%	-	+1%	25°C ± 10°C ambient temperature, 230 VAC input, load changes from 50% to 100%
TURN-ON DELAY TIME	-	-	0.5s	230VAC, full load

GENERAL SPECIFICATIONS

Parameter	Min.	Typ.	Max.	Notes
EFFICIENCY AT 230VAC				
GV6-200B024	91%	93%	-	25°C ambient temperature, full load / 75% load / 50% load
GV6-200B036	91%	94%	-	
DIELECTRIC STRENGTH	INPUT-OUTPUT	-	3750VAC	Max 5mA/60s
	INPUT-PE	-	1875VAC	
	OUTPUT-PE	-	500VAC	
GROUNDING RESISTANCE	-	-	0.1Ω	25A/60s, 25°C ± 10°C ambient temperature
INSULATION RESISTANCE	10MΩ	-	-	Input-Output, Input-PE, Output-PE, 500VDC/60s/25°C/70%RH
MTBF	-	200 000 hours	-	25°C ± 10°C ambient temperature, 230VAC, 80% load (MIL-HDBK-217F)
LIFETIME	-	50 000 hours	-	230VAC, 100% load, tc=75°C (refer to Lifetime Curve)
OPERATING CASE TEMPERATURE FOR SAFETY T_{C-S}	-40°C	-	+90°C	-
OPERATING CASE TEMPERATURE FOR SAFETY T_{C-W}	-40°C	-	+75°C	5 years warranty, humidity 10% to 100% RH
STORAGE TEMPERATURE	-40°C	-	+90°C	Humidity 10% to 100% RH
DIMENSIONS (L x W x H)	175.5 x 67.2 x 37mm			-
NET WEIGHT	800 ± 100g			-
PACKAGE (L x W x H)	15pcs./box; 502 x 372 x 222 mm			-

GV6-200 series

200W Waterproof Constant Voltage LED Driver



SAFETY STANDARDS

SAFETY CATEGORY	COUNTRY / TERRITORY	STANDARDS
CE	Europe	EN61347-1
		EN61347-2-13

EMC STANDARDS

EMC CATEGORY	COUNTRY / TERRITORY	STANDARDS
CE	Europe	EN55015
		EN61000-3-2
		EN61000-3-3
		EN61547

Note: This LED driver meets the EMC specifications above, but EMC performance of luminaire that contains it depends also on the other devices connected to the driver and on the fixture itself.

PROTECTIONS

PARAMETER	Min.	Typ.	Max.	NOTES
INPUT UNDER VOLTAGE PROTECTION	156VAC	-	176VAC	Turn off the output when the input voltage falls below protection voltage.
OVER TEMPERATURE PROTECTION	Turn off the output. Returning to normal after over temperature is removed.			
SHORT CIRCUIT PROTECTION	Hiccup mode. The output shall return to normal when the fault condition is removed.			
OVER CURRENT PROTECTION	Hiccup mode. The output shall return to normal when the fault condition is removed.			
OVER VOLTAGE PROTECTION	Turn off the output voltage, when the fault is removed, restart and resume.			

GV6-200 series

200W Waterproof Constant Voltage LED Driver

MECHANICAL SPECIFICATION

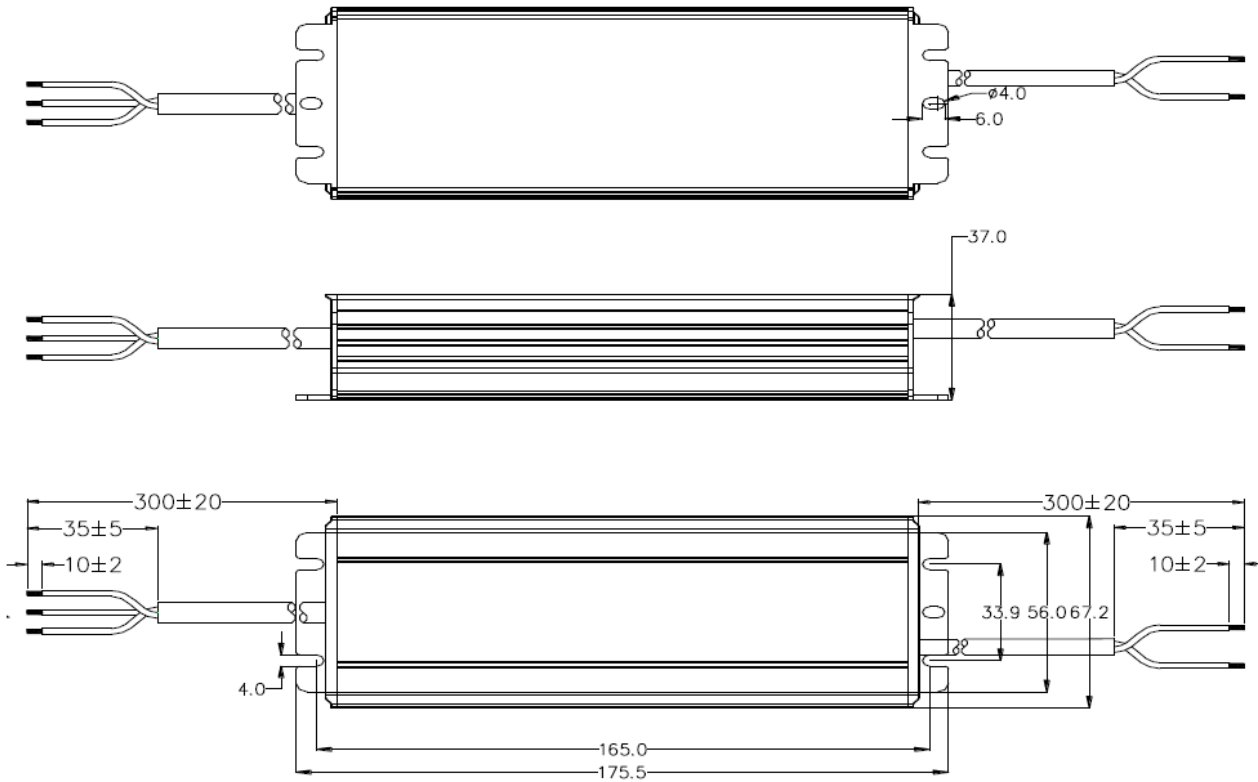

Wire	Specification	Note
INPUT	CCC + VDE, 3x1.0mm ² , length = 300 ± 20mm, peel-length = 35 ± 5mm, Tin-Dip length = 10 ± 2mm	For CCC/CE
	AC/L: brown, AC/N: blue, FG: green/yellow	
OUTPUT	CCC + VDE, 2x1.5mm ² , length = 300 ± 20mm, peel-length = 35 ± 5mm, Tin-Dip length = 10 ± 2mm	For CCC/CE
	V ₀₊ : brown, V ₀₋ : blue	

CHARACTERISTICS

INRUSH CURRENT WAVEFORM

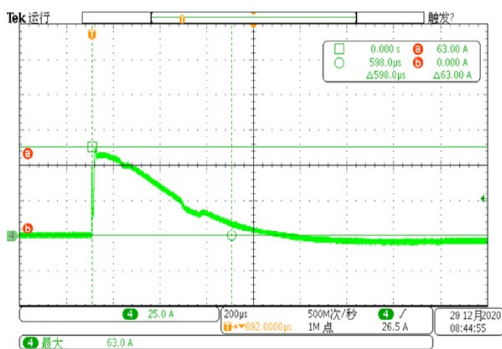

OUTPUT POWER vs. INPUT VOLTAGE CURVE

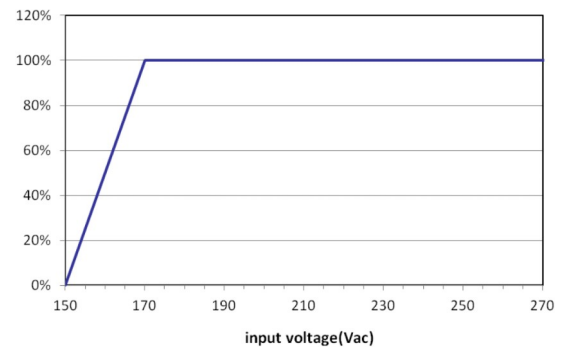

GV6-200 series

200W Waterproof Constant Voltage LED Driver



LIFETIME vs. CASE TEMPERATURE CURVE

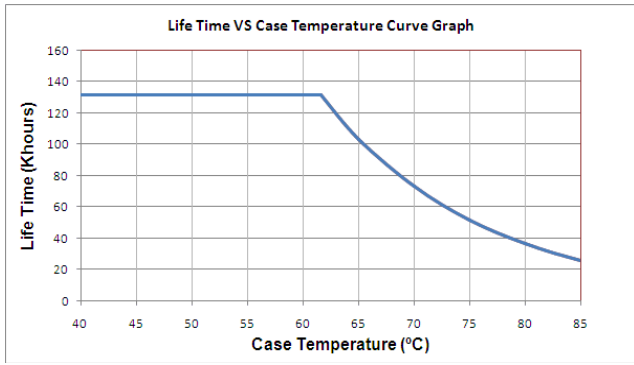

DERATING CURVE

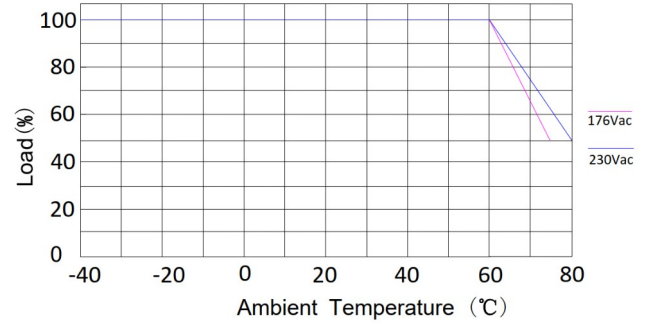

POWER FACTOR vs. LOAD CURVE

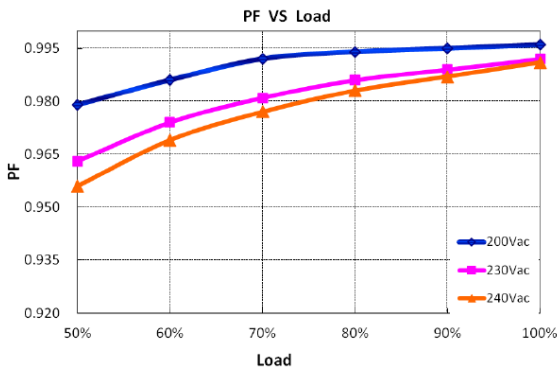

THD vs. LOAD CURVE

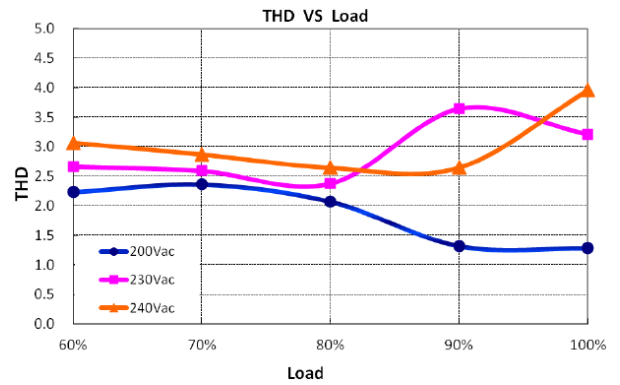

EFFICIENCY vs. LOAD CURVE

