

BIG WHITE[®]

NEW PRODUCTS

04/24



WELL INFORMED

Stay up to date and always receive our current prices. Scan the QR code now and visit us at **slv.com** or one of our partner websites.

BIG WHITE[®]

NEW PRODUCTS







Light is versatile and influences every area of our life. The possibilities offered by SLV for making light a unique experience are just as versatile.

EXPERIENCE LIGHT.

KAMI	8
ONE® FLAT	12
VARYT	14
LALU®	18
PANTILO CONVEX	20
DASAR®	22
HELIA SLIM	24
MODELA	26
D-RING	28
Q-RING	30
ACCESSORIES	32



KAMI

While the members of the KAMI family combine their modern, minimalist design, their characters remain quite different: the new single-lamp recessed ceiling light emits a high-quality light that can be adjusted as required.

The extremely narrow spotlight with a diameter of 5.5 cm is available in black or white with gold, white and black inner rings. The housing can also be removed which makes it easy to replace the luminaire.

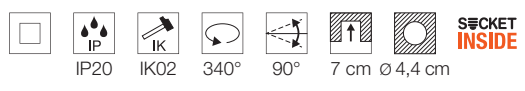
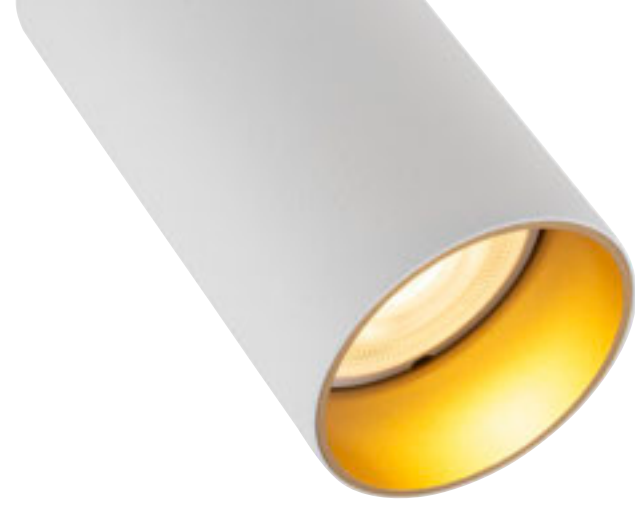

KAMI RL

220-240 V ~50/60 Hz

Material thickness of mounting surface: max. 20mm

- Black
- White / black
- Black / gold
- White
- White / gold

Material: aluminium

Options	Prod. no.	Base	Watt	Dimensions
RL Black, single	1007745	1 x GU10, max. Ø: 5.1 cm	max. 10 W	Ø 5.5 cm; H: 11 cm
Black / gold, single	1007741			
White, single	1007744			
RL White / black, single	1007742	1 x GU10, max. Ø: 5.1 cm	max. 10 W	Ø 5.5 cm; H: 11 cm
White / gold, single	1007740			

	LED QPAR51 GU10	6 W 38°	1005076	2700 K 450 lm EEK=F 6 kWh/1000 h
--	--------------------	-----------	----------------	---





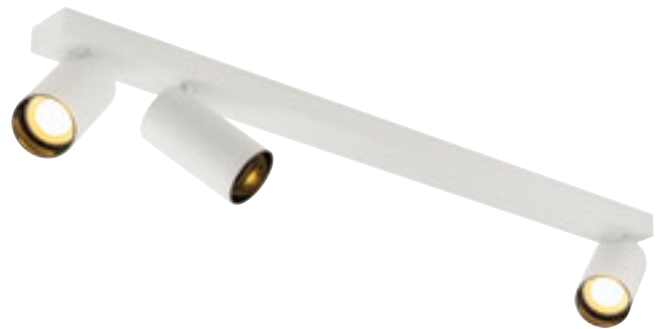

KAMI CW, CL

220-240 V ~50/60 Hz

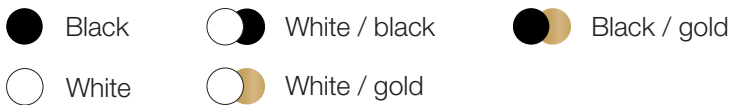

Material: aluminium

Options	Prod. no.	Base	Watt	Dimensions
CW Black, single	1007721	1 x GU10, max. Ø: 5.1 cm	max. 10 W	Ø 5.5 cm; H: 10.5 cm Ceiling rosette: Ø 7 cm, H: 2.4 cm
CW Black / gold, single	1007717			
CW White, single	1007720			
CW White / black, single	1007718	1 x GU10, max. Ø: 5.1 cm	max. 10 W	Ø 5.5 cm; H: 10.5 cm Ceiling rosette: Ø 7 cm, H: 2.4 cm
CW White / gold, single	1007716			
CL Black, double	1007727	2 x GU10, max. Ø: 5.1 cm	max. 10 W	Ø 5.5 cm; H: 10.5 cm Ceiling rosette: L: 17 cm, W: 5 cm, H: 2.4 cm
CL Black / gold, double	1007723			
CL White, double	1007726			
CL White / black, double	1007724	2 x GU10, max. Ø: 5.1 cm	max. 10 W	Ø 5.5 cm; H: 10.5 cm Ceiling rosette: L: 17 cm, W: 5 cm, H: 2.4 cm
CL White / gold, double	1007722			
CL Black, double long	1007733	2 x GU10, max. Ø: 5.1 cm	max. 10 W	Ø 5.5 cm; H: 10.5 cm Ceiling rosette: L: 40 cm, W: 5 cm, H: 2.4 cm
CL Black / gold, double long	1007729			
CL White, double long	1007732			
CL White / black, double long	1007730	2 x GU10, max. Ø: 5.1 cm	max. 10 W	Ø 5.5 cm; H: 10.5 cm Ceiling rosette: L: 40 cm, W: 5 cm, H: 2.4 cm
CL White / gold, double long	1007728			
CL Black, triple long	1007739	3 x GU10, max. Ø: 5.1 cm	max. 10 W	Ø 5.5 cm; H: 10.5 cm Ceiling rosette: L: 70 cm, W: 5 cm, H: 2.4 cm
CL Black / gold, triple long	1007735			
CL White, triple long	1007738			
CL White / black, triple long	1007736	3 x GU10, max. Ø: 5.1 cm	max. 10 W	Ø 5.5 cm; H: 10.5 cm Ceiling rosette: L: 70 cm, W: 5 cm, H: 2.4 cm
CL White / gold, triple long	1007734			



LED QPAR51
GU10

6 W | 38° 1005077

2700 K | 450 lm | EEC=F
6 kWh/1000 h





ONE® FLAT

Clear the ring thrice over for a new, round design: the DALI Touch dimmable ONE® FLAT pendant light adds another new member to the popular SLV light family with three flat light rings that guarantee outstanding performance. The premium LEDs emit an adjustable colour temperature (2700/3000 K) and colour-neutral (CRI>90) light via CCT switch that is especially long-lasting at 50,000 hours. Perfect for upmarket living rooms or commercial areas. A well-rounded lighting experience.

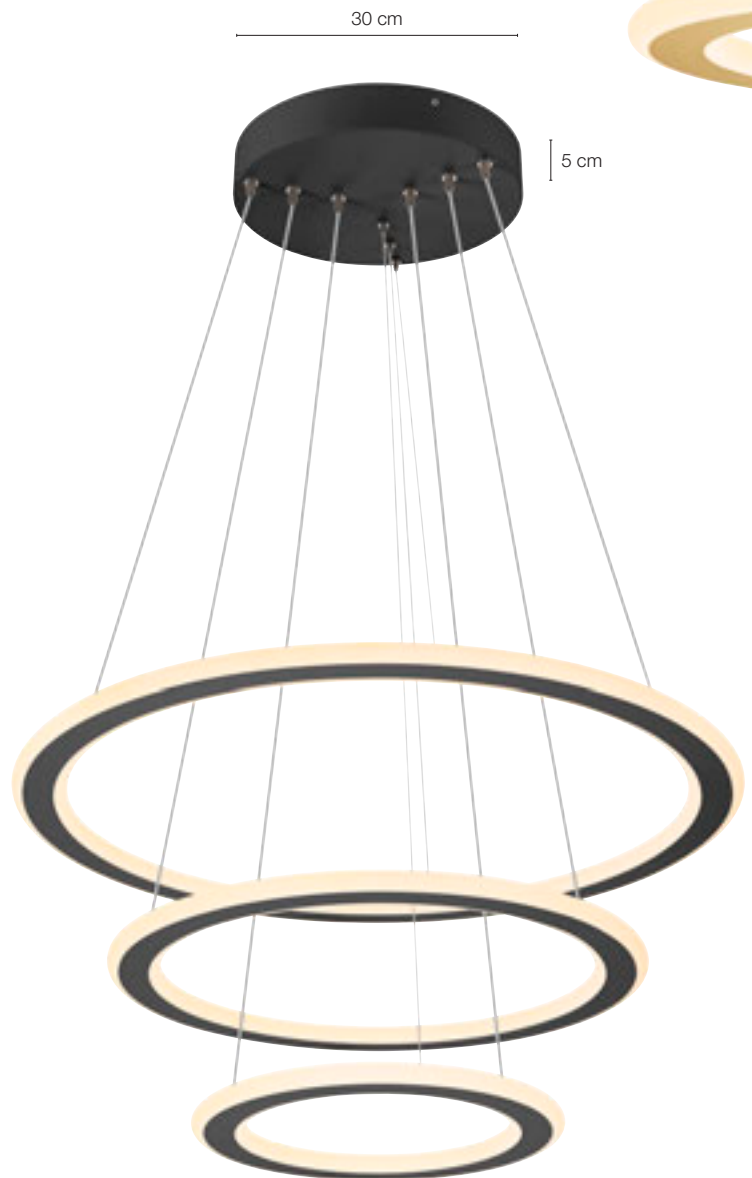

ONE FLAT PD

220-240 V ~50/60 Hz | 1700 mA
Total wattage: 58 W

● Black ○ White ● Brass

Material: aluminium/steel

Options	Prod. no.	Lumen	Kelvin	CRI	Dimensions
PD, triple	Black	1007701			
	White	1007702	3500 lm 3700 lm	2700 K 3000 K	90
	Brass	1007703			ø: 80 cm, H: 2 cm





VARYT

The VARYT pendant light brings modern, elegant and exclusive SLV design to every room. The high-quality aluminium and steel-finished lights are available in four trendsetting colours. The white Triplex glass shade emits a homogenous light that transforms any angle into a feel-good oasis. You can choose from three different glass shades (diamond, lined or pleated) which are available as an accessory.

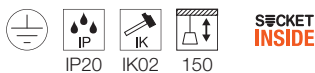

VARYT PD

220-240 V ~50/60 Hz



Material: aluminium

Options	Prod. no.	Base	Watt	Dimensions
PD	Black 1007815	1 x E14 max. Ø: 3.8 cm, L: 11 cm	max. 6 W	Ø 12 cm; H: 17.5 cm Ceiling rosette: Ø 9 cm, H: 2.6 cm
	White 1007814			
	Brass 1007812			
	Chrome 1007813			

LED	4,2 W 320°	1005284	2700 K 380 lm EEK=G 5 kWh/1000 h		
C35	4,2 W 320°	1005285	2700 K 350 lm EEK=G 5 kWh/1000 h		





VARYT

The VARYT glass shades are the perfect addition to every VARYT and a highlight in modern, elegant bathrooms. They create a great atmosphere thanks to their high-quality design and special finish. They also provide individual wall art, giving every room a personal touch.



IK02

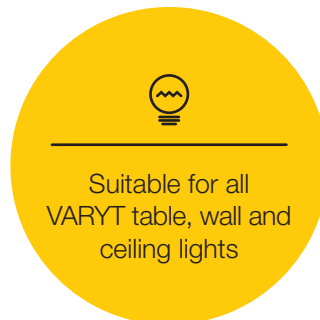

VARYT GLASS SHADE

● Smoked ● Amber ○ White

Material: glass

Product		Prod. no.	Dimensions
Glass shade	Diamond	Smoked	1007858 ø: 11 cm H: 12.5 cm
	Diamond	Amber	1008023 ø: 11 cm H: 12.5 cm
	Lined	White	1007859 ø: 12 cm, H: 13 cm
	Pleated	White	1007860 ø: 11.5 cm, H: 13.5 cm



LED	4,2 W 320°	1005284	2700 K 380 lm EEK=G 5 kWh/1000 h	
C35	4,2 W 320°	1005285	2700 K 350 lm EEK=G 5 kWh/1000 h	





LALU®

Discover a mix & match experience in its most elegant form: LALU® is the new family of SLV pendant lights that combines different lampshades with various bases. This LED version with 48V and warm-white 3000 K emits a light that guarantees an upgrade in any living room when combined with the right components.

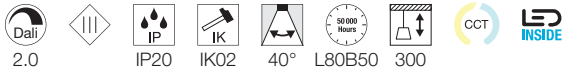

LALU® PD, 48 V LED BASE

48 V | 200 mA
Total wattage: 8 W

● Black ○ White ● Bronze

Material: aluminium

Options	Prod. no.	Lumen	Kelvin	CRI	Dimensions
PD, Base	Black	1007749	700 lm	3000 K	90
	White	1007748			
	Bronze	1007747			

⊕	Prod. no.	Dimensions
LALU® TETRA 14	Black / antique bronze	1007523
	White / gold	1007522
	Antique Bronze	1007521
LALU® TETRA 24	Black / antique bronze	1007526
	White / gold	1007525
	Antique Bronze	1007524
LALU® CONE 15	Black / antique bronze	1007532
	White / gold	1007531
	Antique Bronze	1007530
LALU® ELYPSE 15	Black / antique bronze	1007535
	White / gold	1007534
	Antique Bronze	1007533
LALU® ELYPSE 22	Black / antique bronze	1007538
	White / gold	1007537
	Antique Bronze	1007536
LALU® PLATE 15	Black / antique bronze	1007544
	White / gold	1007543
	Antique Bronze	1007542
LALU® PLATE 22	Black / antique bronze	1007547
	White / gold	1007546
	Antique Bronze	1007545



Combine the colours and shapes of the LALU® Pendant lights



PANTILO CONVEX

PANTILO CONVEX is the name of the SLV pendant light with a unique design, whose outwardly curved glass shade is now also available in the colours copper, gold and white. The various cable lengths (150 cm / 250 cm), which can also be shortened, cover all installation heights. A suspended highlight in glass for hotels, restaurants or private living spaces, whose eye-catching effect can be further enhanced by installing several lights as a cloud.

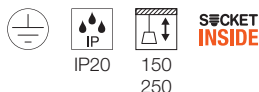

PANTILO CONVEX PD

220-240 V ~50/60 Hz

Copper
 Gold
 White

Material: steel and glass

Options	Prod. no.	Base	Watt	Dimensions
29 PD	Copper 1007879	1 x E27 max. Ø: 10 cm, L: 20 cm	max. 40 W	Ø: 29 cm; H: 25 cm Open cable end, cable length: 250 cm
	Gold 1007880			
	White 1007881			
40 PD	Copper 1007876	1 x E27 max. Ø: 15 cm, L: 30 cm	max. 40 W	Ø: 40 cm; H: 35 cm Ceiling rosette: Ø 12 cm, H: 3 cm, cable length: 150 cm
	Gold 1007877			
	White 1007878			

⊕	Prod. no.
Single-phase adapter PANTILO CONVEX 29	Black 143120
	White 143121
	Grey 143124
3-phase adapter PANTILO CONVEX 29	Black 145990
	White 145994
	Grey 1001542
FITU single ceiling rosette PANTILO CONVEX 29	Black 132600
	White 132601
	Gold 1002163
	Chrome 132605



A60

7,5 W | 180°

1005305

2700 K | 720 lm | EEK=F
8 kWh/1000 h





DASAR®

The DASAR® Recessed floor lights make every building shine in high gloss. The separately available interchangeable reflectors (15°, 36°, 50°) offer maximum flexibility so that even special building structures can be optimally emphasised. Perfect for illuminating buildings sufficiently and stylishly.



DASAR® M RL

220-240 V ~50/60 Hz | 200 mA

Total wattage: 6.5 W

● Stainless steel

Material: stainless steel 316

Options	Prod. no.	Lumen	Kelvin	CRI	Dimensions
RL, round Stainless steel	1007810	450 lm	3000 K	80	ø: 13 cm, D: 14 cm
RL, square Stainless steel	1007811	450 lm	3000 K	80	L: 12 cm, W: 12 cm, D: 14 cm

⊕	Prod. no.	Dimensions
Mounting housing Black	1007822	ø: 31 cm, D: 18 cm
Reflector 15° Silver	1007683	
Reflector 36° Silver	1007684	
Reflector 50° Silver	1007685	

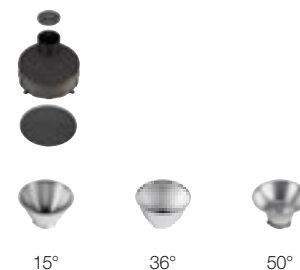



HELIA SLIM

Whether with one or two light heads – the HELIA SLIM ground spike light blends naturally into any environment with its minimalist design and black surface. The high-quality coating also enables long-lasting use near the coast.



60 cm

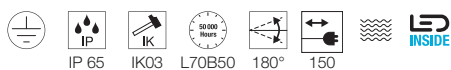

HELIA SLIM POLE

220-240 V ~50/60 Hz | 500 mA

Total wattage: 6 W / 12 W

● Black

Material: aluminium

Options	Prod. no.	Lumen	Kelvin	CRI	Dimensions
Pole single Black	1007868	450 lm	3000 K	80	W: 12 cm, H: 60 cm, D: 8.5 cm
Pole double Black	1007869	900 lm	3000 K	80	W: 12 cm, H: 60 cm, D: 12 cm



MODELA

The unusually shaped MODELA up/down wall light now brings the trend colour gold to outdoor areas. The softly curved design creates a sharply defined light cone that sets beautiful accents.



MODELA WL

220-240 V ~50 Hz | 95 mA
Total wattage: 7.5W

Black
 White
 Black / gold
 White / gold

Material: aluminium

Options	Prod. no.	Lumen	Kelvin	CRI	Dimensions	
WL	Black	1007808	2 x 385 lm	2700 K	80	W: 9.7 cm, H: 20.2 cm, D: 9 cm
up/	White	1007809	2 x 400 lm			
down	Black / gold	1007807	2 x 405 lm			
	White / gold	1007806	2 x 405 lm			



D-RING

The wall lights in the RING family pick up on the trend towards organic shapes. The different diameters offer a wide range of design options for indirect light. Thanks to the special surface treatment, it can also be used near the coast. The option of combining multiple colours and sizes creates a real eye-catcher on any wall.



D-RING WL

220-240 V ~50 Hz | 95 / 190 mA

Total wattage: 7.5 W / 15 W

● Black ○ White

Material: aluminium



Options	Prod. no.	Lumen	Kelvin	CRI	Dimensions
WL S	Black	630 lm	2700 K	80	ø: 16 cm, D: 5 cm
		650 lm	3000 K		
	White	790 lm	2700 K		
		820 lm	3000 K		
WL M	Black	1260 lm	2700 K	80	ø: 25 cm, D: 5 cm
		1360 lm	3000 K		
	White	1540 lm	2700 K		
		1590 lm	3000 K		



Q-RING

The new Q-RING family elegantly picks up on the trend towards organic shapes. The indirect and warm white light (3000 K) illuminates façades discreetly and glare-free. Thanks to the special surface treatment, it can also be used near the coast.



Q-RING WL

220-240 V ~50 Hz | 240 mA
Total wattage: 10 W

● Black ○ White

Material: aluminium



Options	Prod. no.	Lumen	Kelvin	CRI	Dimensions	
WL	Black	1007918	950 lm	3000 K	80	ø: 27 cm, D: 11 cm
	White	1007919				
WL Sensor	Black	1007916	950 lm	3000 K	80	ø: 27 cm, D: 11 cm
	White	1007917				

NEW ACCESSORIES

VINOLINA TWO CHARGING STATION

VINOLINA TWO is the name of the high-quality, aluminium-finished table lamp that can be used outdoors thanks to its IP65 protection rating. Featuring a timeless design, a single battery charge emits up to 10 hours of dimmable light dispersed upwards and downwards whereby the colour temperature can be set. It is charged via the charging base, to which up to six lights can be connected.

+

Only compatible with
VINOLINA TWO
(1007693, 1007692,
1007697, 1007695,
1007694, 1007696)

The 6-plate charging station is only compatible with VINOLINA TWO. For even more charging capacity, the charging plates can be connected together and operated via a charging cable.

VINOLINA TWO is not included in the scope of delivery.



LED POWER SUPPLY 25 W | 24 V

● Black

Material: plastic / plastic

Product		Prod. no.	Total wattage	IP	IK	Dimensions
VINOLINA TWO 6-plate charging station 5 V	Black	1007698	37 W	20	04	L: 46.2 cm W: 32.6 cm H: 5 cm

Product		Prod. no.
Power cable 1.8 m	Black	1008029



ONE® ACOUSTIC FELT PLATE

The ONE® pendant lights are also extremely popular in offices. Thanks to their premium LEDS and excellent lighting properties, they emit a high-quality light that is ideal for working. This sound-absorbing felt plate for the ONE® 80/ ONE® CUBE, which is available separately, takes accoustics to a whole new level.

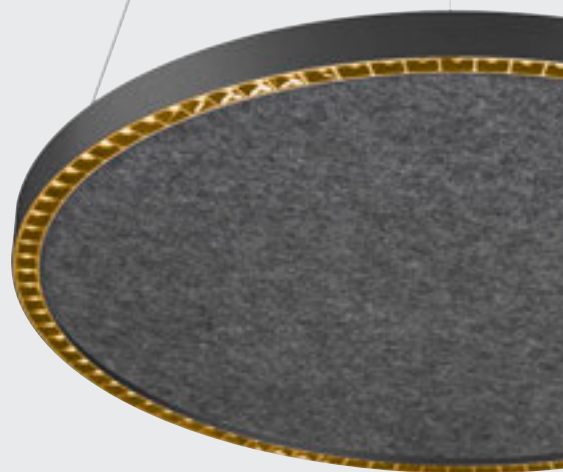

Felt is a very popular material for acoustic solutions. Acoustic felt reduces noise and sound, contributing to better room acoustics.

ONE® ACOUSTIC FELT PLATE

● Grey

Material: felt

Product	Prod. no.	Dimensions
ONE® Acoustic felt plate ONE® 80 / ONE® CUBE	Grey 1007746	Ø: 75.5 cm, H: 3.8 cm



S-TRACK 3-PHASE SYSTEM CONNECTOR

The new adjustable connectors make planning an S-TRACK 3-phase system even easier. As they can be adjusted from left to right (earth inside and outside), the track layout can be configured even more easily. Two products now become one – this not only makes planning easier, but also saves space in your warehouse.

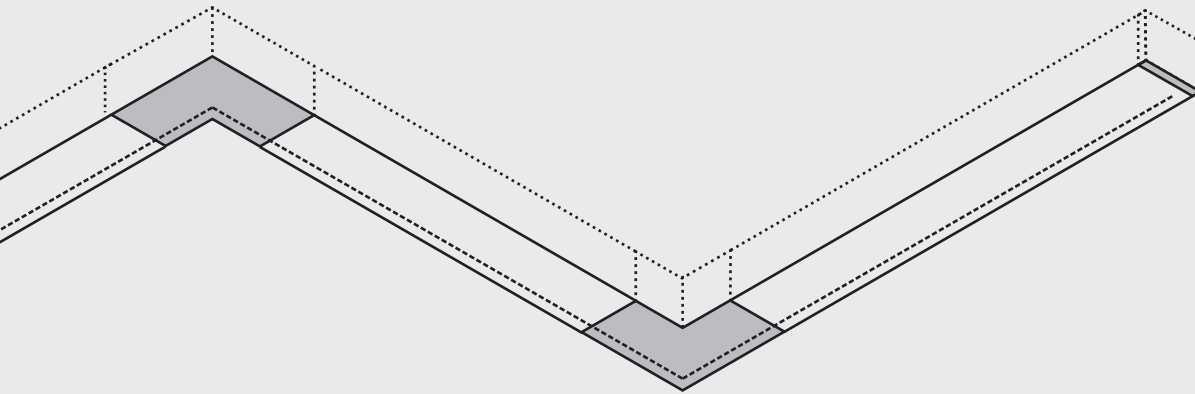

S-TRACK 3-PHASE SYSTEM L-CONNECTOR

220-250 V ~50/60 Hz

● Black ○ White

Material: polycarbonate (PC)

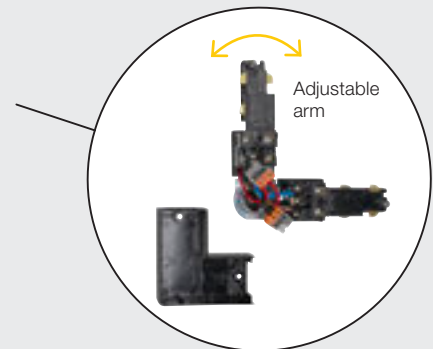

Product	Prod. no.	Current load	IP	Dimensions	
S-TRACK L-connector DALI, adjustable	Black	1007816	16 A	20	L: 11.9 cm, W: 11.9 cm, H: 3.3 cm
	White	1007817			

S-TRACK 3-PHASE SYSTEM T-CONNECTOR

220-250 V ~50/60 Hz

● Black ○ White

Material: polycarbonate (PC)

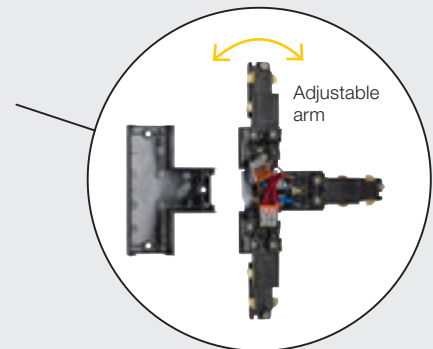

Product	Prod. no.	Current load	IP	Dimensions	
S-TRACK T-connector DALI, adjustable, left	Black	1007818	16 A	20	L: 20.3 cm W: 11.9 cm H: 3.3 cm
	White	1007819			
S-TRACK T-connector DALI, adjustable, right	Black	1007820	16 A	20	L: 20.3 cm W: 11.9 cm H: 3.3 cm
	White	1007821			

48V SYSTEM INTRACK POWER ADAPTER

Maximum minimalism and simple elegance: the LED driver is designed for flexible use in the 48V TRACK mounting tracks. Thanks to the four-wire 220V-240V / DALI through-wiring, controllable lighting concepts with particularly small tracks and spotlights are easy to realise.

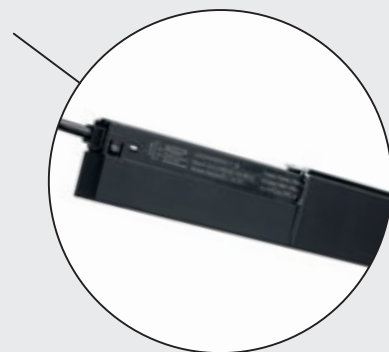

48V SYSTEM INTRACK POWER ADAPTER

220-240 V ~50/60 Hz

● Black ○ White

Material: polycarbonate (PC)



Product		Prod. no.	Output from / to		IP	Dimensions
48V SYSTEM Intrack Power Adapter, incl. DALI through-wiring	Black	1007870	0 W / 100 W	DALI	20	L: 29.75 cm, W: 1.6 cm, H: 1.9 cm
	White	1007871				
48V SYSTEM Intrack Power Adapter, incl. DALI through-wiring	Black	1007872	0 W / 250 W	DALI	20	L: 26.8 cm, W: 2.2 cm, H: 4.35 cm
	White	1007873				

SINGLE-PHASE SYSTEM CEILING ROSETTE

With the ceiling rosette, all spots with 85 mm single-phase adapter can be installed as stand-alone lights detached from the track system.

SINGLE-PHASE SYSTEM CEILING ROSETTE

220-250 V ~50/60 Hz

● Black ○ White

Material: polycarbonate (PC)



Product		Prod. no.	Current load		IP	Dimensions
Single-phase system ceiling rosette 2.0	Black	1007926	6 A		20	Ø: 11.5 cm, H: 2.5 cm
	White	1007927				
	Grey	1007928				

LED QT14 G9

With a colour temperature of 2700 Kelvin, the SLV LED lamp with G9 base and QT14 shape is ideal for creating a cosy lighting atmosphere indoors.



LED QT14 G9

White

Material: ceramic

Product	Prod. no.	Kelvin	Lumen	Lifetime	CRI	Wattage	IP	Dimensions	EEC
LED QT14 G9	White 1007455	2700 K	450 300°	L70B50 h 15,000	90	3,6	20	Ø: 1.8 cm L: 5.4 cm	E

LED EMERGENCY CONVERTER SET

This independent LED emergency converted with over-discharge protection and DALI 2-interface & automatic test function includes intelligent charge control and a lithium battery (LiFePO4). During emergency operation (3 hrs), a constant output with a forward voltage of 6-54V is sent to a connected LED module / light. The emergency converter set also includes a wired switch for performing manual tests as well as a bicoloured, wired status display. The status display can be integrated into metal/wood or plasterboard sheets using the adapters supplied.



EMERGENCY LIGHT FEATURE

White

Material: polycarbonate (PC)

Product	Prod. no.	Output	IP	Dimensions
LED emergency converter set DALI	White 1007892	6-54 V Lithium battery (LiFePO 4)	DALI 20	L: 27.4 cm, W: 4.2 cm, H: 2.6 cm Battery housing: L: 12.5 cm, W: 6.7 cm, H: 2.9 cm

SMART REMOTE CONTROLLER

With its stable touch colour wheel, the energy-saving ZigBee CCT/RGBW remote control enables fast and precise coloured light control over distances of up to 30 m. Thanks to the “find and bind mode”, it can be easily coupled with universal ZigBee DIM, CCT, RGB, RGBW and RGB+CCT ZigBee gateway products. Three groups for connecting a maximum of 30 lighting devices and six preset scenes are supported. It is also possible to save and call up five scenes.

SMART REMOTE CONTROLLER

White

Material: polycarbonate (PC)



Product		Prod. no.	Output		IP	Dimensions
SMART REMOTE CONTROLLER ZigBee remote control, CCT/RGBW	White	1007827	Battery operation 1.5 V, 2 x AAA	ZigBee	20	L: 14 cm, W: 4.4 cm, H: 1.7 cm

COLOUR EXPLANATION



Anthracite

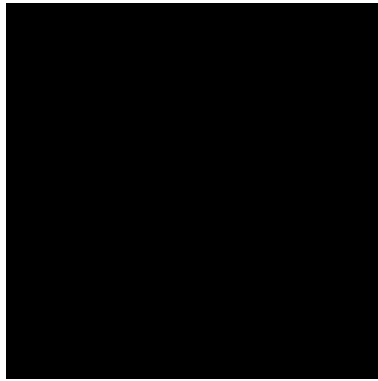

Black



Grey

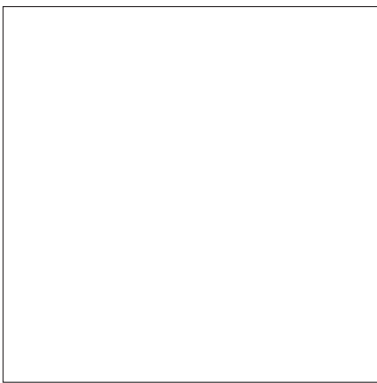

White



Chrome



Stainless steel



Gold



Brass

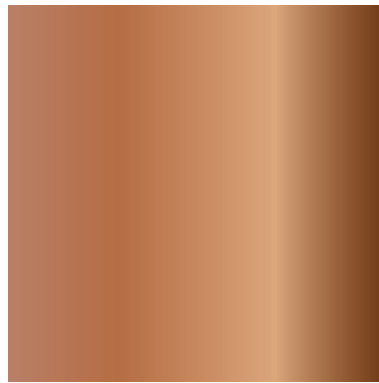

Bronze

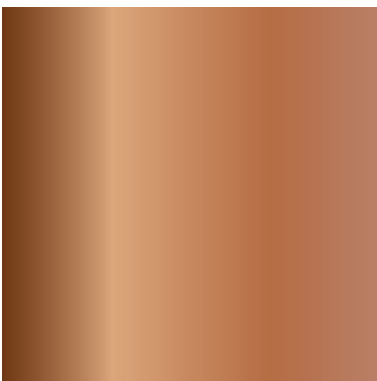

Copper

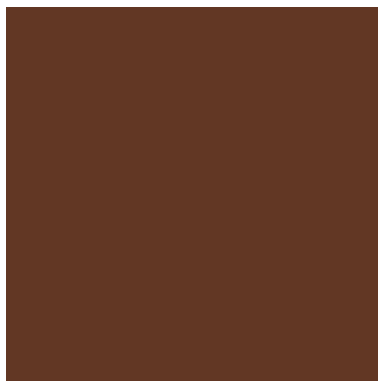

Amber



Smoked

EXPLANATION OF SYMBOLS



Dimmable with:

- **C** = Trailing-edge phase dimmer
- **SWITCH** = Switch/button or touch control on the light
- **DALI** = DALI bus system



Protection classes:

- Protection class I / protective conductor
- Protection class II / protection by double or reinforced insulation



IP protection type:

Indicates the suitability of electrical equipment for different environmental conditions.



IK impact resistance rating

The IK impact resistance level is a measure of the resistance of housings for electrical equipment to mechanical stress, especially impact stress.



Half-diffusion angle:

Describes the beam angle in degrees. The smaller the angle, the more concentrated the light will be.



Preservation of luminous flux:

Describes the amount by which the luminous flux of an LED decreases during a specified period.

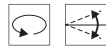

Rotation and pivoting capacity in degrees:

- Rotation range
- Pivot range



- Power cable length in cm
- Supply cable length in cm (with open cable end)



Pendant cable length in cm



Through-wiring possible



The weight capacity of the product up to specified value in tonnes. Measurements based on concrete installation.



Specification of the installation depth



Specification of the cut-out shape and the installation dimensions



Sea-air resistant coating



CCT switch:

By means of an integrated CCT switch, the light colour can be changed from 2700 K, 3000 K, 4000 K to 6500 K during installation.



- Products with integrated LEDs
- Products with lamp socket

A large part of the products shown in this brochure are protected by trademarks, registered designs, utility models or patents. Any violation of these property rights or the use of text and layout design or copyrighted images without our authorisation will be prosecuted. The illustrations and information contained in this brochure are for illustrative purposes only and are not legally binding in terms of colour, shape, design or technical details. Product descriptions and specifications are subject to correction and amendment.

All of the products in our range are subject to our strict quality assurance procedures and comply with generally applicable standards. This brochure contains a general range and is not country specific. Any deviations from country-specific guidelines must be clarified before ordering. SLV cannot be held responsible for any deviations in terms of technical standards. All weights and dimensions are given in kg and cm respectively unless stated otherwise. We reserve the right to make technical changes!

SLV is entitled to adjust the respective price list to changing market conditions, in the event of significant changes in procurement costs, changes in value added tax or procurement prices.

SLV GmbH | Daimlerstraße 21-23, 52531 Uebach-Palenberg, Germany, +49 (0) 2451 4833-333, info@slv.de
SLV Austria | +49 (2451) 4833 355, export@slv.de
SLV Belgium | Herentalsebaan 429, B-2160 Wommelgem, +32 (0) 3/385 30 08, info@slv.be
SLV Nordics | Flade Engvej 4, 9900 Frederikshavn, Denmark, +45 9310 7474, info@nordics.slv.com
SLV France | Zac du Martelet, 88, rue Henri Dépaigneux, F-69400 Limas, +33 4 74 02 71 20, infofr@slv.com
SLV LIGHTING UK LTD | Unit E Chiltern Park, Boscombe Road, Dunstable, LU5 5LT, +44 (0)203 968 11 00, sales@uk.slv.com
SLV Italia S.r.l. | Via Lecco, 19/D, 23896 Bevera di Sirtori (LC), +39 039 5983575, infoit@slv.com
SLV Nederland | Kazernestraat 19, 5928 NL Venlo, +31 773204343, info@slv.nl
SLV Norway AS | Vangsveien 10, 1814 Askim, +47 48225500, post@slvnorway.no
SLV Poland | ul. Poznańska 356, 05-850 Ożarów Maz., Polska, (0048 22) 722-49-75, slv@slv.pl
SLV Portugal | R. Margarida de Abreu, no13 – Lj2, 1900-314 Lisboa, +351 210 185 961, info@pt.slv.com
SLV Swiss SA | Route du Bey 6 Box 1-4, Z.I. La Jonnaire, CH-1847 Rennaz, +41 218113232, info@slv-swiss.ch
SLV d.o.o | Barjanska cesta 50, SI-1000 Ljubljana, +386 1 2009 730, info@slv.si
SLV Spain | Antic Camí Ral Valencia, 38, L17, 08860 Castelldefels, Barcelona, 931 168 161, info@slv.es
SLV Czech s.r.o. | V Sedlici 28/17, CZ-160 00 Praha 6, +420 739 282 151, info@cz.slv.com

slv.com