

Specification

Integrated Furniture Lighting

LS0709



LS0709

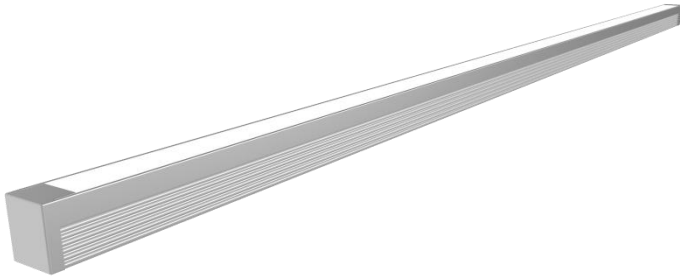

Example of application: wooden decorative board on the wall

Cutout:W8.5*D10mm fixed by glass cement



Features

DLS1.0, a special local auxiliary lighting system, can be widely used in various interior decoration scenarios and local light spaces. A touch of auxiliary decorative lighting in addition to the basic lighting creates different atmospheres and visual enjoyment.

Embellish life with light that follows you whenever you go.

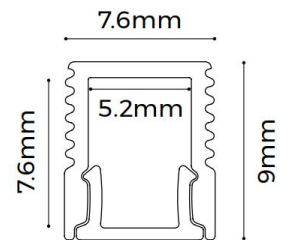

- 1、 “Dots-free”lighting
Perfect homogenous lighting.
- 2、 Various diffuser options
Several options of diffusers, In various shapes and light distribution plans Complete with everything needed
- 3、 “Two” end caps
Two options of end cap for two ways of wire outgoing, Close-fitting design without screws makes installation much easier
- 4、 Various installation methods
A wide range of installation accessories wider applications
- 5、 “One” cut.
Consistent length between diffuser and profile
- 6、 Smart control for unlimited possibilities
Perfectly match the profiles like customized, Control by hand sweep or touching

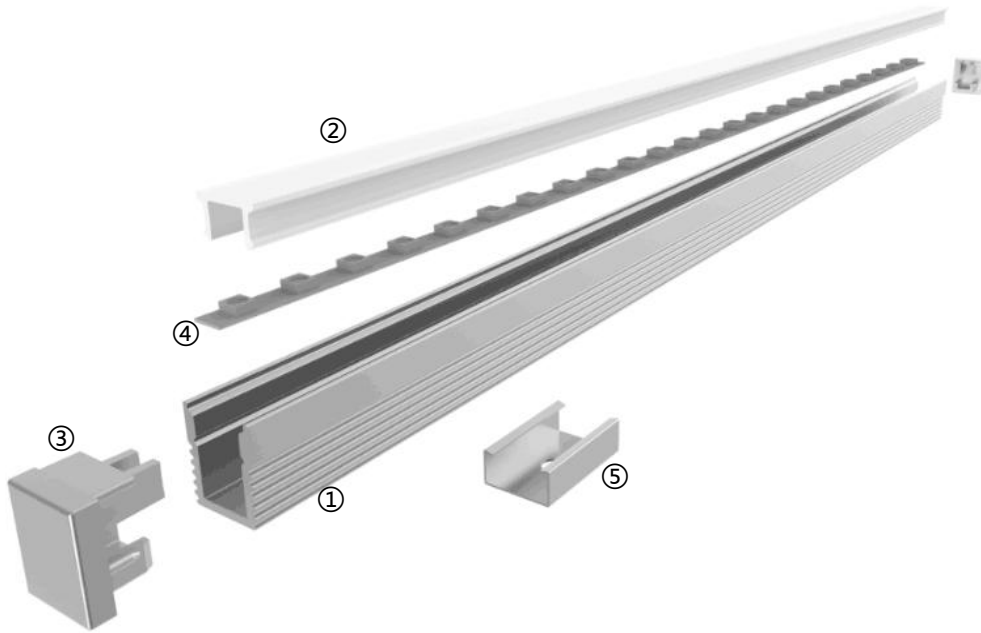

Details





Standard Configuration

Picture	Item	Parameter	Model
	① Profile	Material: AL6063-T5 Profile weight: 0.187kg/2.5m Size: L2500*W7.6*H9mm Surface processing: Silver alkali sand oxidation film	/
	② Cover	Type: Frosted diffuser Material: PC Light transmittance: 55% Size: L2500*W6.4*H3.7mm (shrink) 0.8mm/m when the temperature rises (drops) 10°C.	/
	③ End caps	Size: L9*W7.6*H8mm	EC-LS0709

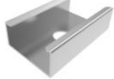

Optional Accessories

Picture	Item	Parameter	Model
	②Black Cover	Type: Black diffuser Material: PC Light transmittance: 15% Size: L2500*W6.4*H3.7mm (shrink) 0.8mm/m when the temperature rises (drops) 10°C.	CV-LR0812
	④FPC strip D6140-24V-4mm	Material: FPC, CCT: 2700/3000/4000/6000K; Ra > 90; Voltage:24V; Power: 6.6W/m; Lumen: 710Lm/m; PCB width: 4mm; Minimum cut: 50mm;	D6140-24V- 4mm
	⑤Recessed clips	Size: L15*W9.7*H4.5mm	CP-03

Optical Parameter

The testing result of 1M luminaire (with " D6140-24V-4mm " and diffuser)

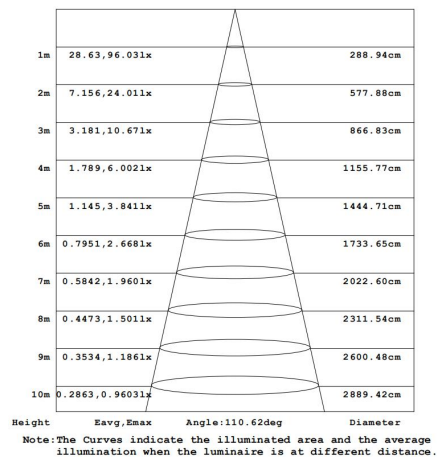
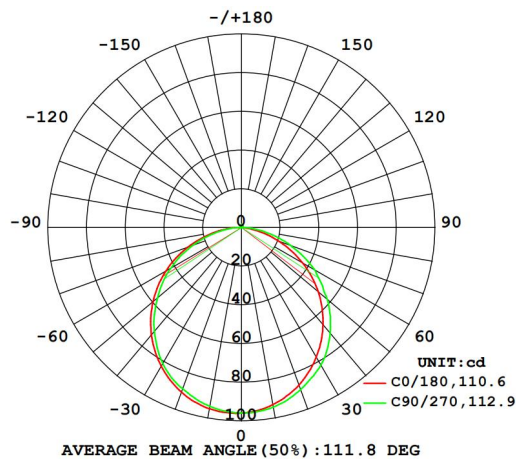

Package

Mode 1 :

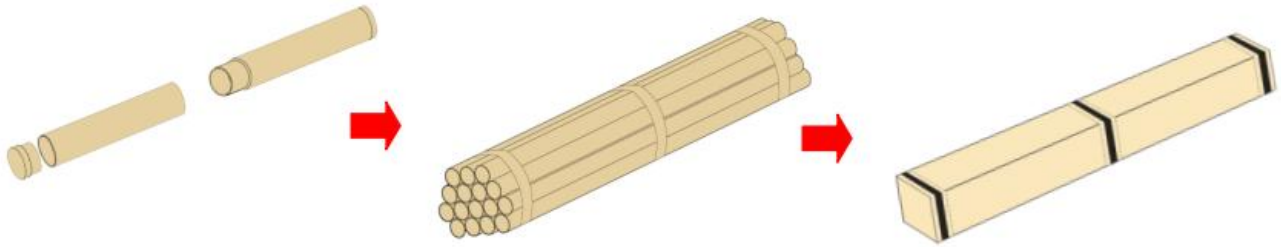

Mode 2 :

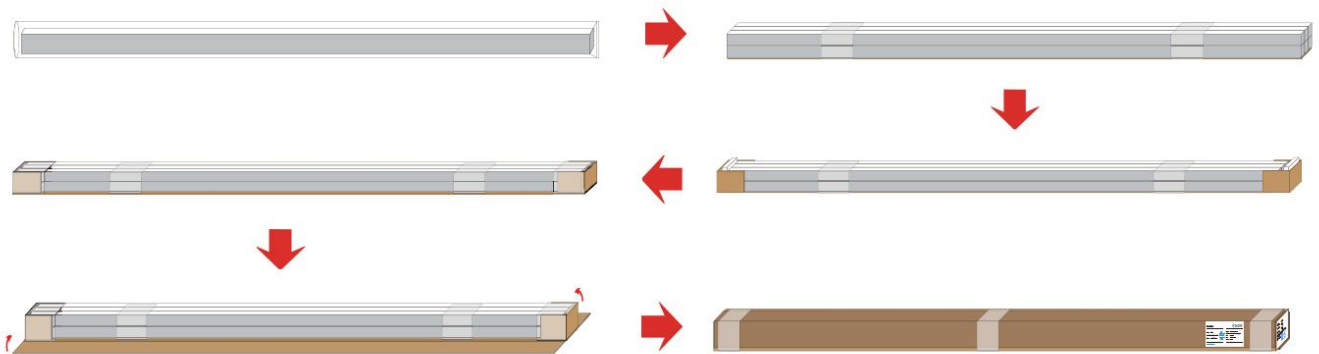

Components	Packaging material	Size(mm)	NW(kg)	GW(kg)	Content
Single piece	Hat box	Φ22mm*2580mm	0.222	0.49	1pcs/box
Whole bundle	Hat box	2580*250*165mm	13.986	32.87	63pcs/box
Whole box packaging	Paper box	2580*95*100mm	13.986	16.99	63pcs/box

